

medartis

PRECISION IN FIXATION

SURGICAL TECHNIQUE

Fusion System 3.5

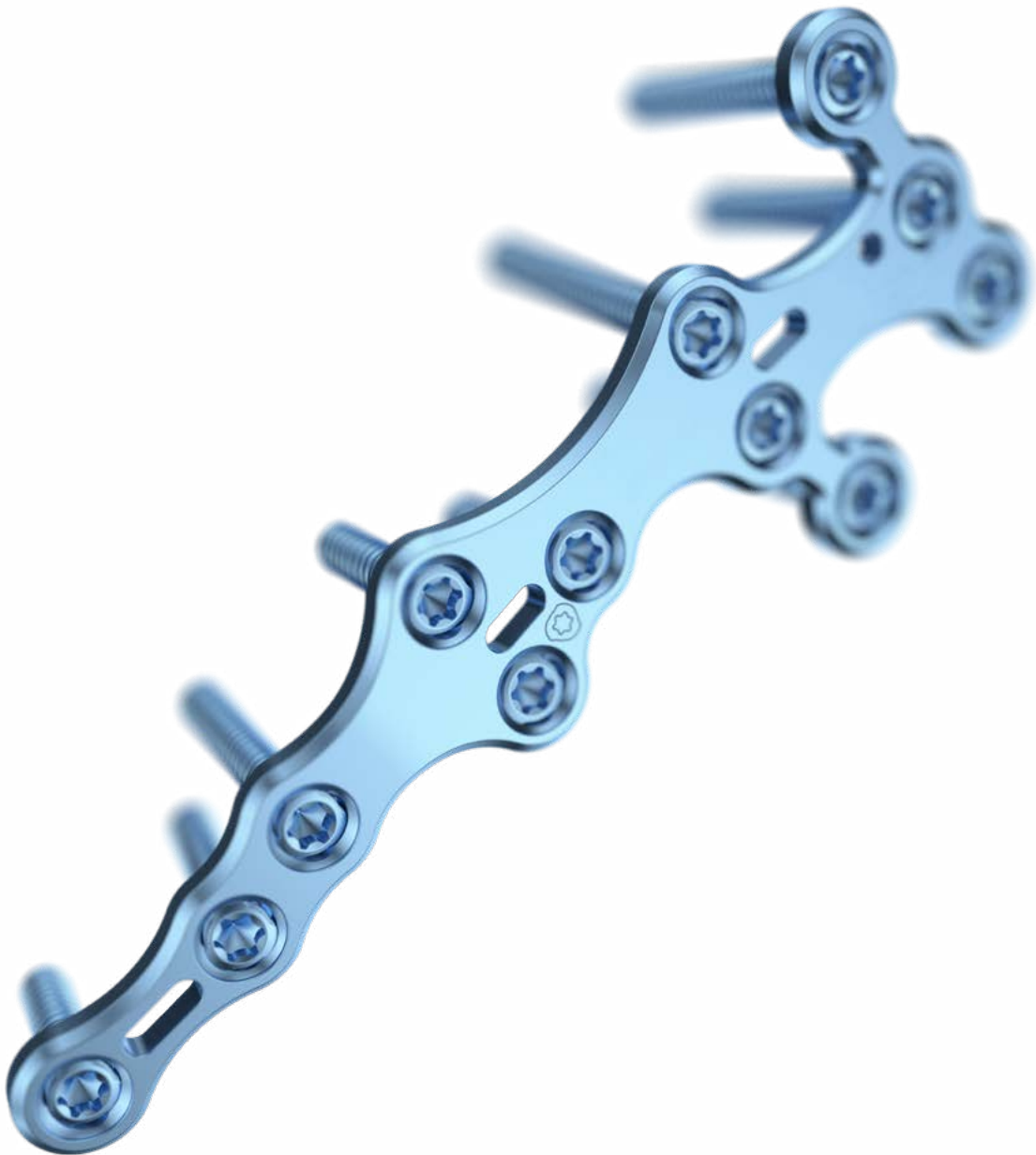

APTUS Foot

Contents

| | |
|----|---|
| 3 | Introduction |
| 3 | Product Materials |
| 3 | Indications |
| 3 | Contraindications |
| 3 | Color Coding |
| 3 | Possible Combination of Plates and Screws |
| 3 | Symbols |
| 4 | System Overview |
| 4 | TriLock Fusion Plates |
| 5 | TriLock Talonavicular Fusion Plates |
| 5 | TriLock Wing Plates |
| 5 | TriLock Butterfly Plates |
| 6 | Treatment Concept |
| 7 | Instrument Application |
| 7 | General Instrument Application |
| 7 | Sizing Templates |
| 8 | Plate Holding and Positioning |
| 8 | Bending |
| 9 | Bending of Flaps |
| 9 | Cutting |
| 11 | Drilling |
| 13 | Assigning the Screw Length |
| 14 | Screw Pick-Up |
| 15 | Specific Instrument Application |
| 15 | Compression Forceps |
| 15 | Forceps Application with 2.0 mm K-Wires |
| 16 | Forceps Application with 2.0 mm Olive K-Wires |
| 17 | K-Wire Spreader for 1.6 or 2.0 mm K-Wires |
| 17 | Lamina Spreader |
| 18 | Surgical Techniques |
| 18 | General Surgical Techniques |
| 18 | Lag Screw Technique |
| 19 | Specific Surgical Techniques |
| 19 | Introduction |
| 21 | TriLock TNC Fusion Plates / TriLock Proximal Medial Column Fusion Plates |
| 23 | TriLock NCM Fusion Plates / TriLock Distal Medial Column Fusion Plates |
| 25 | TriLock TNCM Fusion Plates / TriLock Medial Column Fusion Plates |
| 27 | TriLock Talonavicular Fusion Plates |
| 28 | Explantation |
| 28 | Explantation of Fusion Plates |
| 29 | TriLock Locking Technology |
| 29 | Correct Application of the TriLock Locking Technology |
| 30 | Correct Locking ($\pm 15^\circ$) of the TriLock Screws in the Fusion System 3.5 |
| 31 | Implants, Instruments and Containers |

For further information regarding the APTUS product line visit www.medartis.com

Introduction

Product Materials

| Product | Material |
|-------------|--|
| Plates | Pure titanium, titanium alloy |
| Screws | Titanium alloy |
| K-wires | Stainless steel |
| Instruments | Stainless steel, PEEK, aluminum, Nitinol, silicone or titanium |
| Containers | Stainless steel, aluminum, PEEK, polyphenylsulfone, polyurethane, silicone |

Indications

APTUS Foot

Fractures, osteotomies and arthrodesis of the bone of the foot

- Fusion System
 - osteotomies and arthrodeses of the tarsals and metatarsals

Contraindications

- Preexisting or suspected infection at or near the implantation site
- Known allergies and / or hypersensitivity to implant materials
- Inferior or insufficient bone quality to securely anchor the implant
- Patients who are incapacitated and / or uncooperative during the treatment phase
- Growth plates are not to be blocked with plates and screws

Color Coding

| System Size | Color Code |
|-------------|------------|
| 3.5 | Green |

Plates and Screws

Special implant plates and screws have their own color:

| | |
|---------------------|------------------------------|
| Implant plates blue | TriLock plates (locking) |
| Implant screws gold | Cortical screws (fixation) |
| Implant screws blue | TriLock screws (locking) |
| Implant screws pink | Cancellous screws (fixation) |

Possible Combination of Plates and Screws

Plates and screws can be combined within one system size:

3.5 TriLock Plates

- 3.5 TriLock Screws, HexaDrive 15
- 3.5 Cortical Screws, HexaDrive 15
- 4.0 Cancellous Screws, HexaDrive 15

Symbols

 HexaDrive



























 TriLock screw hole on sizing templates



System Overview





TriLock Fusion Plates

The 3.5 TriLock fusion plates are available in three sizes (S, M, L) and in left and right versions. The plates are available sterile and non-sterile.

| Offerings | Left | | | | Right | | | |
|---|---|---|---|---|--|---|---|---|
| Plate Size | Large | Large | Medium | Small | Small | Medium | Large | Large |
| Plate Thickness | 2.5 mm | 2.0 mm | 2.0 mm | 2.0 mm | 2.0 mm | 2.0 mm | 2.0 mm | 2.5 mm |
|  | TriLock TNC Fusion Plates / Proximal Medial Column Fusion Plates | | | | | | | |
| |  |  |  |  |  |  |  |  |
| | A-4960.01S | A-4960.21 | A-4960.31 | A-4960.41 | A-4960.42 | A-4960.32 | A-4960.22 | A-4960.02S |
|  | TriLock NCM Fusion Plates / Distal Medial Column Fusion Plates | | | | | | | |
| |  |  |  |  |  |  |  |  |
| | A-4960.03S | A-4960.23 | A-4960.33 | A-4960.43 | A-4960.44 | A-4960.34 | A-4960.24 | A-4960.04S |
|  | TriLock TNCM Fusion Plates / Medial Column Fusion Plates | | | | | | | |
| |  |  |  |  |  |  |  |  |
| | A-4960.05S | A-4960.25 | A-4960.35 | A-4960.45 | A-4960.46 | A-4960.36 | A-4960.26 | A-4960.06S |



TriLock Talonavicular Fusion Plates

The 3.5 TriLock talonavicular fusion plates are available in two sizes (S, L) and in left and right versions. The plates are available sterile and non-sterile.

| Offerings | Left | | Right | |
|---|---|---|---|---|
| Plate Size | Large | Small | Small | Large |
| Plate Thickness | 2.0 mm | 2.0 mm | 2.0 mm | 2.0 mm |
|  |  |  |  |  |
| | A-4960.11 | A-4960.13 | A-4960.14 | A-4960.12 |





TriLock Wing Plates

The 3.5 TriLock wing plates are available in two sizes (S, L). The plates are available sterile and non-sterile.

| Plate Size | Small | Large |
|---|---|---|
| Plate Thickness | 2.0 mm | 2.0 mm |
|  |  |  |
| | A-4950.91 | A-4950.92 |





TriLock Butterfly Plates

The 3.5 TriLock butterfly plates are available in three sizes (S, M, L). The plates are available sterile and non-sterile.

| Plate Size | Small | Medium | Large |
|---|---|---|---|
| Plate Thickness | 2.0 mm | 2.0 mm | 2.0 mm |
|  |  |  |  |
| | A-4950.93 | A-4950.94 | A-4950.95 |

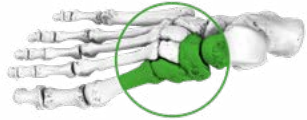
Treatment Concept

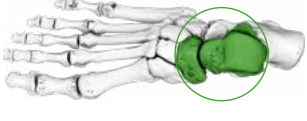
The table below lists typical clinical findings which can be treated with the implants of the Fusion System 3.5.

| | TNC Fusion Plate 3.5 A-4960.21/22/31/32/41/42 A-4960.01S-02S | NCM Fusion Plate 3.5 A-4960.23/24/33/34/43/44 A-4960.03S-04S | TNCM Fusion Plate 3.5 A-4960.25/26/35/36/45/46 A-4960.05S-06S | Talonavicular Fusion Plate 3.5 A-4960.11/12/13/14 | Wing Plate 3.5 A-4950.91/92 | Butterfly Plate 3.5 A-4950.93/94/95 |
|---|--|--|---|--|--------------------------------|--|
| Talonavicular, Naviculocuneiform and Tarsometatarsal-1 Joint TN, NC and TMT-1 Joint  | | | | | | |
| Talonavicular and Naviculocuneiform Joint TN and NC Joint  | | | | | | |
| Naviculocuneiform and Tarsometatarsal-1 Joint NC and TMT-1 Joint  | | | | | | |
| Talonavicular Joint TN Joint  | | | | | | |
| Lisfranc Fusion  | | | | | | |
| TMT-1 Fusion, Navicular-Cuneiform Fusion, Calcaneo-Cuboid Fusion Cuneiform Fusion, Lateral Column Lengthening Osteotomy  | | | | | | |

The above-mentioned information is a recommendation only. The operating surgeon is solely responsible for selecting the appropriate implant for the specific case.

Instrument Application

General Instrument Application

Sizing Templates

Sizing templates facilitate the intraoperative selection of the appropriate implant. Sizing templates for the Fusion System 3.5 are available according to chapter "Implants, Instruments and Containers".

The sizing templates feature symbols that indicate the type of the screw hole and its position on the respective implant:



for a TriLock screw hole (locking) using a TriLock or cortical screw

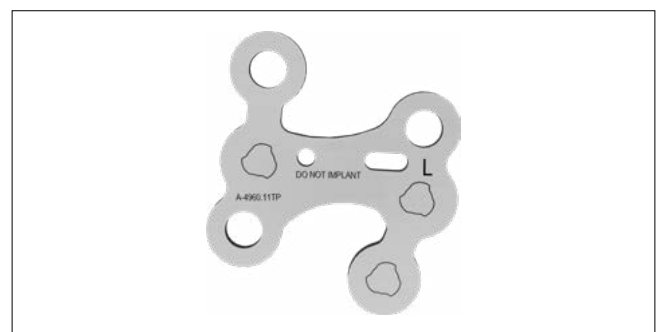

Sizing template with TriLock screw hole symbol

The article number of the sizing template (e.g. A-4960.11TP) corresponds to the article number of the sterile implant (e.g. A-4960.11S). The suffix TP stands for template.



A-4960.11TP
Template for A-4960.11S

Use appropriate K-wires to temporarily fix the sizing template to the bone, if necessary.

Notice

Do not implant sizing templates.
Do not bend or cut sizing templates.

Plate Holding and Positioning

The TriLock ends of the 2.8 / 3.5 plate holding and positioning instrument (A-2950) can be locked in the TriLock holes of the plate. The plate holding and positioning instrument facilitates positioning, moving and holding the implant on the bone. The plate holding and positioning instrument can be used with all TriLock 2.8 or 3.5 plate holes.



A-2950
2.8 / 3.5 Plate Holding and Positioning Instrument

Bending

If required, the plates can be bent with the 3.5 / 4.0 plate bending pliers (A-2940).

Only the flaps of the of the 3.5 TriLock medial column fusion plates (A-4960.01S–06S) can be bent.



A-2940
3.5 / 4.0 Plate Bending Pliers

Warning

Wrong bending of the plate may lead to impaired functionality and postoperative construct failure.

The plate bending pliers with pin are always used in pairs.

The labeled side of the plate must always face upward when inserting the plate into the bending pliers (A-2940).

When bending a plate, the plate bending pliers must be held so that the letters "UP" are legible from above. This ensures that the plate holes are not damaged.

While bending, the plate must always be held at two adjacent holes to prevent contour deformation of the intermediate plate hole.



Warning

Do not bend the plate by more than 30°. Bending the plate further may deform the plate holes and may cause the plate to break postoperatively.

**Warning**

Repeatedly bending the plate in opposite directions may cause the plate to break postoperatively. Always use the provided plate bending pliers to avoid damaging the plate holes. Damaged plate holes prevent correct and secure seating of the screw in the plate and increase the risk of system failure.



Bending of Flaps

Flaps of all 3.5 fusion plates can be bent using the 3.5 / 4.0 plate bending pliers (A-2940).

Warning

The flaps can be bent once. Bending of the flaps in opposite directions may cause the flap to break intra- or postoperatively.

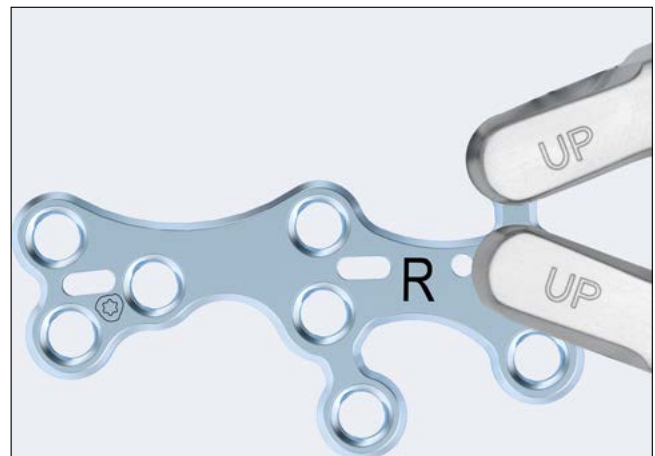

Cutting

If required, the plate cutting pliers (A-2045) can be used to cut all plates as well as K-wires up to a diameter of 2.0 mm.

Due to the thickness of the 3.5 TriLock medial column fusion plates (A-4960.01S-06S), the plate cutting pliers cannot be used.

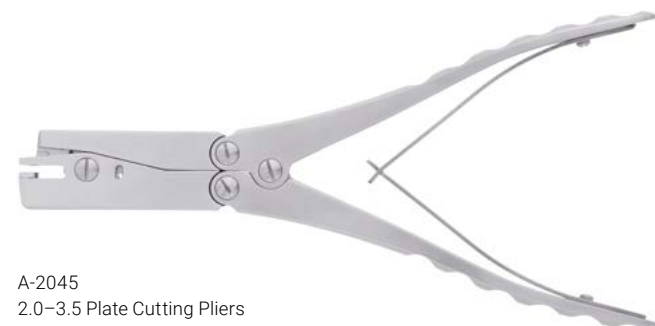

A-2045
2.0-3.5 Plate Cutting Pliers

Ensure that there are no remaining plate segments in the cutting pliers (visual check). Insert the plate from the front into the open cutting pliers. Always ensure that the labeled side of the plate is facing upwards. Hold the implantable plate segment with your hand during and after cutting.

Recommendation

To facilitate the insertion of the plate, support the cutting pliers slightly with your middle finger.

You can visually check the desired cutting line through the cutting window in the head of the pliers. Always leave enough material on the rest of the plate to keep the adjacent hole intact.

Always cut the plate holes individually. If two plate holes need to be cut off, two cutting procedures are necessary.

Warning

Wrong cutting of the plate may result in sharp edges and lead to injuries of surrounding tissues.

Shorten the K-wires by inserting the wire through the opening located on the side of the plate cutting pliers. Cut the wire by pressing the pliers.

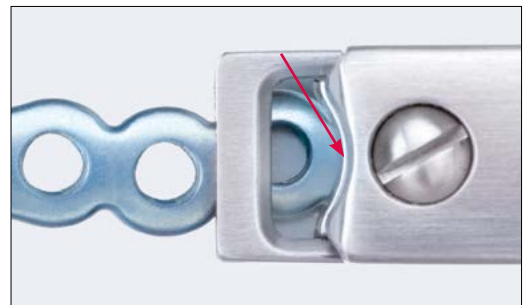

Drilling

Color-coded twist drills are available for every APTUS system size. All twist drills are color-coded with a ring system.

| System Size | Color Code |
|-------------|------------|
| 3.5 | Green |

There are two different types of twist drills for every system size: The core hole drill is characterized by one colored ring. The gliding hole drill (for lag screw technique) is characterized by two colored rings.

The twist drill \varnothing 2.6 mm for core holes (A-3934) has a golden shaft to match the golden color of the 3.5 cortical screws.

Hole Drilling for 3.5 screws

3.5 Cortical



A-3934

Core hole drill with \varnothing 2.6 mm = One colored ring

3.5 TriLock



A-3931

Core hole drill with \varnothing 3.0 mm = One colored ring



A-3933

Gliding hole drill with \varnothing 3.6 mm = Two colored rings

For 3.5 screws, the twist drill must always be guided by the drill guide (A-2925 or A-2927) or the self-holding drill sleeve (A-2921).

The double-ended drill guide (A-2925) can be used for lag screw technique, 3.5 cortical and 4.0 cancellous screws.

The drill guide (A-2927) is used for TriLock screws.



A-2925

3.5 Drill Guide, Cortical, Drill \varnothing 2.6 / 3.6 mm



A-2927

3.5 Drill Guide, TriLock, Drill \varnothing 3.0 mm

The self-holding drill sleeve (A-2921) can be locked with a clockwise turn in the TriLock holes of the plate (no more than $\pm 15^\circ$). It thus performs all the functions of a drill guide without the need to be held.

Warning

The twist drill must always be guided by the drill guide (A-2925 or A-2927) or the self-holding drill sleeve (A-2921). This prevents damage to the screw hole and protects the surrounding tissue from direct contact with the drill. The drill guide also serves to limit the pivoting angle.

Warning

For TriLock plates ensure that the screw holes are predrilled with a pivoting angle of no more than $\pm 15^\circ$. For this purpose, the drill guide features a limit stop of $\pm 15^\circ$. A predrilled pivoting angle of $> 15^\circ$ no longer allows the TriLock screws to correctly lock in the plate.



A-2921
3.5 Drill Sleeve, Self-Holding



Assigning the Screw Length

The depth gauge (A-2931) is used to assign the ideal screw length for use in monocortical or bicortical screw fixation.



A-2931
3.5/4.0 Depth Gauge, 10–70 mm

Retract the slider of the depth gauge.

The depth gauge caliper has a hooked tip that is either inserted to the bottom of the hole or is used to catch the far cortex of the bone. When using the depth gauge, the caliper stays static, only the slider is adjusted.

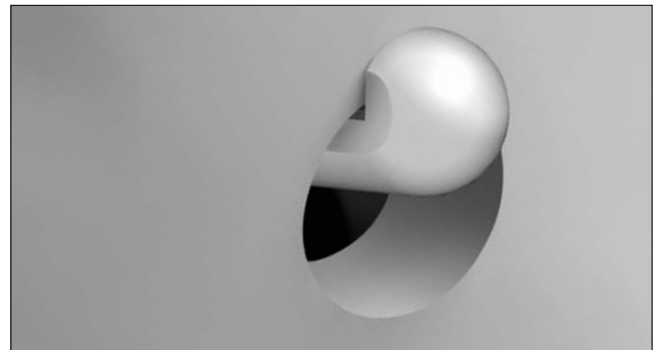

To assign the screw length, place the distal end of the slider onto the implant plate or directly onto the bone (e.g. for fracture fixation with lag screws).

The ideal screw length for the assigned drill hole can be read on the scale of the depth gauge.



When inserting a 3.5 screw, the screw length may also be assigned directly from the scale on the twist drill \varnothing 2.6 mm (A-3934) or \varnothing 3.0 mm (A-3931) in combination with the drill guide (A-2925 or A-2927). The length is assigned from the end of the drill guide.

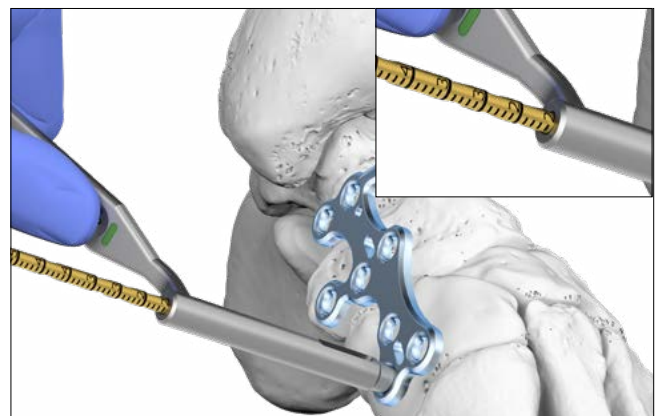

Screw Pick-Up

The screwdriver blade (A-2911) features the HexaDrive self-holding system.

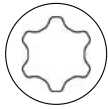

A-2075
T-Handle with Quick Connector, AO



A-2911
3.5 / 4.0 Screwdriver Blade, HD15, AO



A-2074
Handle with Quick Connector, AO

To remove the screws from the implant container, insert the appropriately color-coded screwdriver blade perpendicularly into the screw head of the desired screw and pick up the screw with axial pressure.

Notice

The screw will not hold without axial pressure.

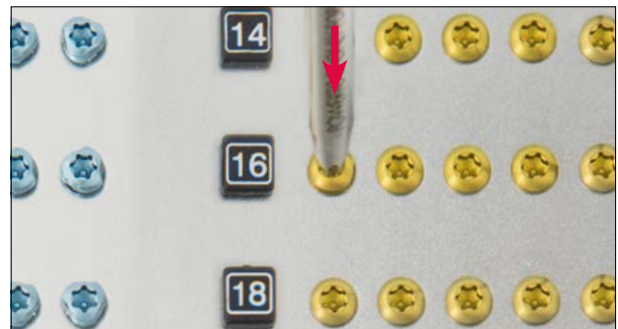

Caution

Vertically extract the screw from the compartment. Picking up the screw repeatedly may lead to permanent deformation of the self-retaining area of the HexaDrive inside the screw head. Therefore, the screw may no longer be able to be picked up correctly. In this case, a new screw has to be used.

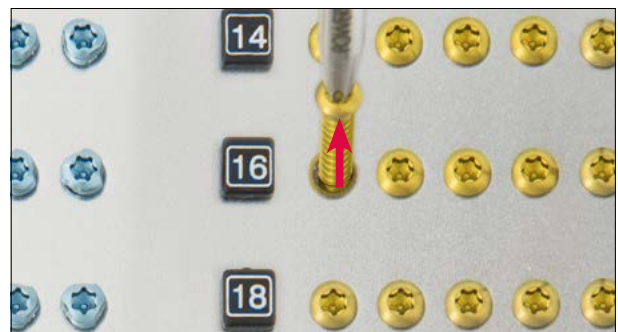

Notice

Check the screw length and diameter at the scale of the measuring module. The screw length is determined at the end of the screw head.

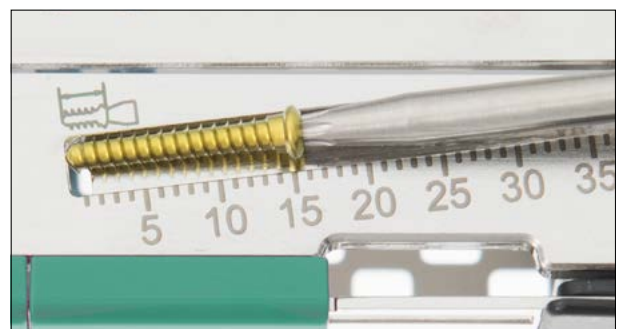

Specific Instrument Application

Compression Forceps

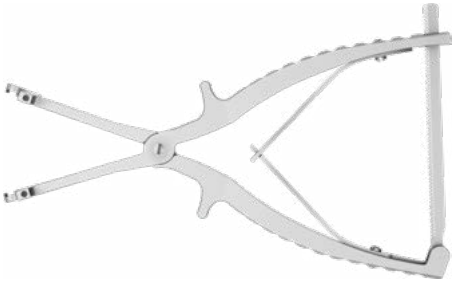
| Compression Forceps | Plates with K-Wire Hole and K-Wire Slot for Compression | Ø K-Wire / Olive K-Wire |
|--|--|-------------------------|
|  <p>A-2044 Compression Forceps for K-Wires Ø 2.0 mm</p> | <ul style="list-style-type: none"> - TriLock fusion plates - TriLock talonavicular fusion plates | 2.0 mm |

Forceps Application with 2.0 mm K-Wires

Always use the compression forceps (A-2044) with the flat or straight ends on the bone or plate. The curved ends have to point up.

1. Inserting the K-wires

Place a 2.0 mm K-wire (A-5040.61 or A-5042.61) through the K-wire hole more or less perpendicularly to the bone surface. Slide the forceps over the first wire and insert the second K-wire through the far end of the K-wire slot. The instrument should be in direct contact with the bone or the plate surface.

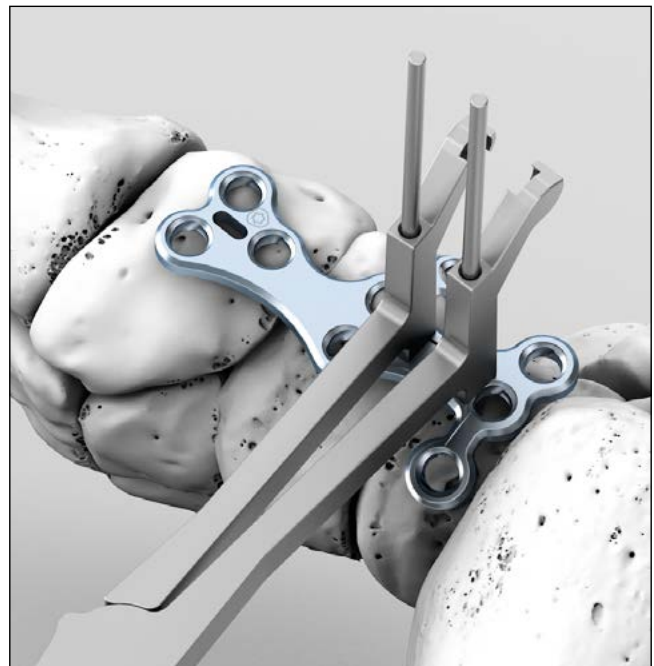

2. Applying compression

Apply compression to the K-wires by gently squeezing the handles of the compression forceps.

Warning

Do not overcompress. Too high compression could possibly damage either the bone or the K-wires. Use X-ray control to verify the correct reduction and compression.

Forceps Application with 2.0 mm Olive K-Wires

When using the 2.0 mm olive K-wires (A-5045.xx), always have the curved ends of the instrument (A-2044) pointing towards the plate.

1. Inserting the olive K-wires

Choose two olive K-wires with adequate length for bicortical fixation. Insert the first olive K-wire through the K-wire hole. To minimize stripping of the K-wire thread, slow the insertion when the olive of the K-wire gets close to the plate. Do not overtighten. Insert the second olive K-wire through the far end of the K-wire slot until the olive is in contact with the plate. There should be a sufficient amount of force holding the plate to the bone.

2. Applying compression

Place the curved end with the cupped mouth pieces of the forceps over the olives and apply gentle compression.

Warning

Do not overcompress. Too high compression could possibly damage either the bone or the K-wires. Use X-ray control to verify the correct reduction and compression.



K-Wire Spreader for 1.6 or 2.0 mm K-Wires

To perform a distraction using the K-wire spreader for 1.6 mm or 2.0 mm K-wires, press the handles together. To keep the distraction of the osteotomy, the ratchet of the spreaders can be fixed.

Caution

Overdistraction could damage the bone and / or the K-wires. If the forceps are placed too high away from the bone, the K-wires may possibly bend.

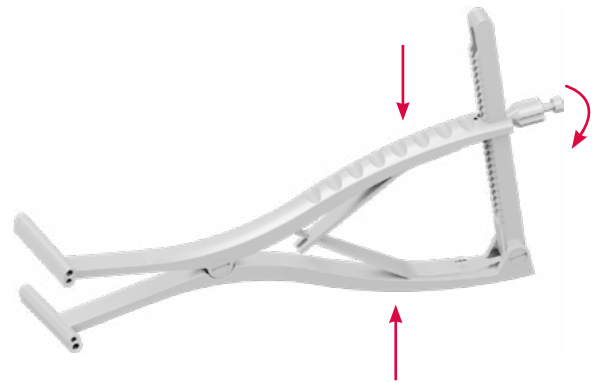

A-2056
K-Wire Spreader

Lamina Spreader

To perform a distraction using the lamina spreader, press the handles together. To keep the required distraction, the ratchet of the spreaders can be fixed.

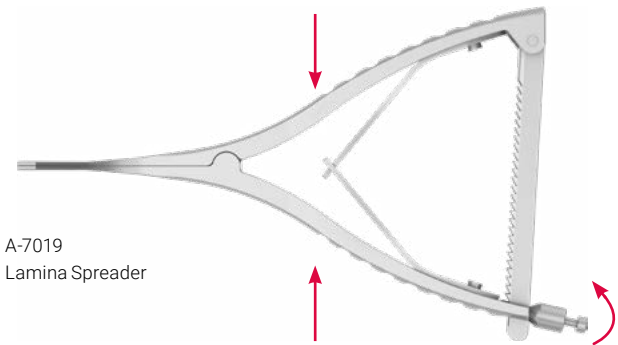

A-7019
Lamina Spreader

Surgical Techniques

General Surgical Techniques

Lag Screw Technique

Warning

Incorrect application of the lag screw technique may result in postoperative loss of reduction.

1. Drilling the gliding hole

Drill the gliding hole using the twist drill marked with two green rings (A-3933, Ø 3.6 mm) in combination with the end of the drill guide (A-2925) labeled with "LAG". Drill perpendicular to the fracture line.

Do not drill further than the fracture line.

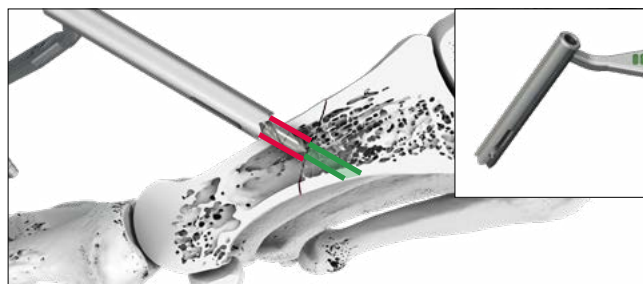

2. Drilling the core hole

Place the other end of the drill guide (A-2925) onto the drilled gliding hole and use the twist drill for core holes with one green ring (A-3934, Ø 2.6 mm) to drill the core hole.

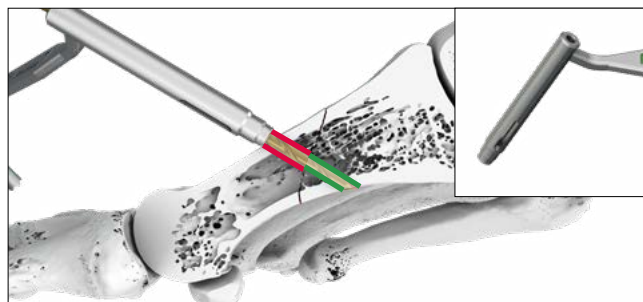

3. Compressing the fracture

Compress the fracture with the corresponding cortical screw (A-5901.xx).

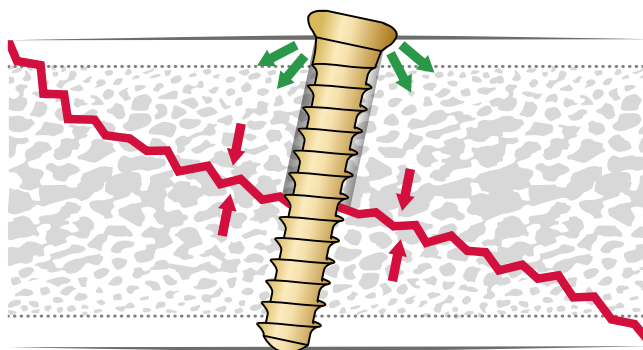

4. Optional steps before compression

If required, use the countersink (A-3930) to create a recess in the bone for the screw head.



A-3930

Caution

Use the handle (A-2074) instead of a power tool to reduce the risk of countersinking too far through the near cortex.

Specific Surgical Techniques

Introduction

1. Preparing the joint

Expose and prepare the joints to be fused. For distraction of the individual joints, use the K-wire spreader (A-2056) with 2.0 mm K-wires or the lamina spreader (A-7019).

2. Selection of the correct plate

As per surgeon's preference, additional compression and stability across the joints can be performed with additional intramedullary fixation devices, such as an APTUS cannulated compression screw or a lag screw.

– 3.5 TriLock TNC fusion plates / 3.5 TriLock proximal medial column fusion plates

Plates are designed to fuse the TN and NC joint.

– 3.5 TriLock NCM fusion plates / 3.5 TriLock distal medial column fusion plates

Plates are designed to fuse the NC and TMT-1 joint.

– 3.5 TriLock TNCM fusion plates / 3.5 TriLock medial column fusion plates

Plates are designed to fuse the TN, NC and TMT-1 joint.

– 3.5 TriLock talonavicular fusion plates

Plates are designed to fuse the TN joint.

3. Bending

For additional bending, the plates can be bent to the patient's anatomy with the supplied bending pliers (see section "Bending").

4. Temporarily fixing the plate

For temporary plate fixation, 2.0 mm K-wires (A-5040.61 or A-5042.61) or 2.0 mm olive K-wires (A-5045.61 – 67) may be used. Insert the K-wires or olive K-wires through the K-wire slots or the K-wire holes of the plate.

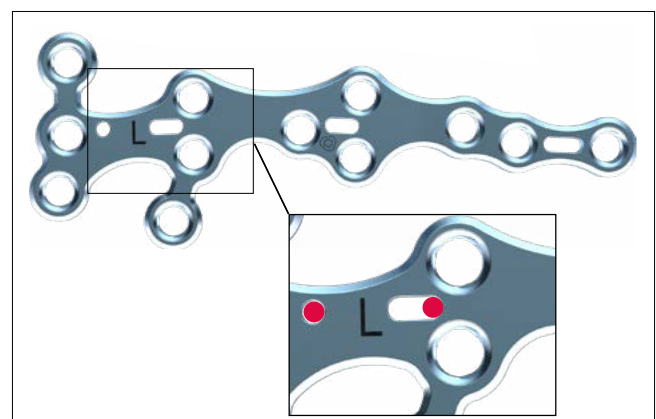

5. Compressing the individual joints with compression forceps

For additional compression insert the 2.0 mm K-wires or 2.0 mm olive K-wires bicortically in the K-wire hole and in the far side of the K-wire slot to allow for compression. Use the compression forceps (A-2044) to apply compression over the joints.

It is recommended to start the compression of the joints from proximal to distal.

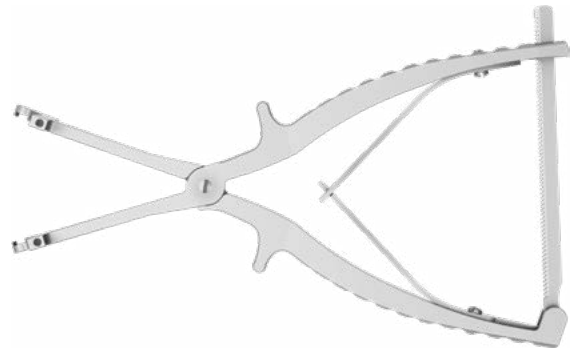

A-2044
Compression Forceps for K-Wires Ø 2.0 mm

Warning

For the treatment of Charcot foot it is necessary to use a 3.5 TriLock medial column fusion plate (A-4960.01S-06S) in combination with an intramedullary fixation (“beaming”) device, such as an additional APTUS cannulated compression screw (SpeedTip CCS 7.0). The intramedullary fixation helps to achieve additional stability across the joints and realignment of the medial column. Insufficient stability may lead to plate deformation and / or breakage.



6. Fixing the plate

All screw holes accept 3.5 cortical screws (A-5901.xx), 3.5 TriLock screws (A-5950.xx) and 4.0 cancellous screws (A-5990.xx).

The choice of angular stable TriLock screws (A-5950.xx) generally provides a higher stability of the construct, especially in the case of poor bone quality.

Warning

Insert at least two and when possible three screws in each bone/bone fragment when fixing the plate (A-4950.91-95, 4960.01S-06S/21-26/31-36/41-46/11-14).

TriLock TNC Fusion Plates

(A-4960.21/22/31/32/41/42)

TriLock Proximal Medial Column Fusion Plates

(A-4960.01S-02S)

Talonavicular and naviculocuneiform joint

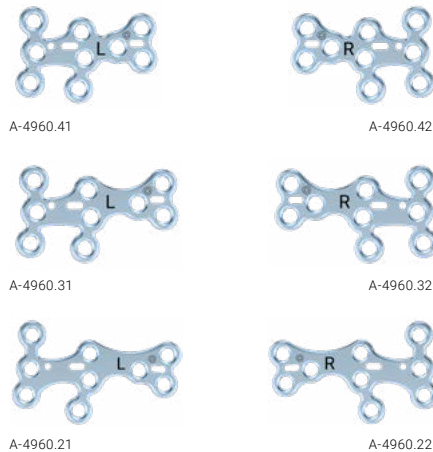
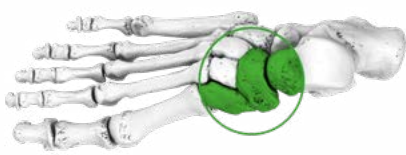

1. Fusion of the talonavicular joint

Step 1

Fix the plate with a minimum of one screw in the talus. Pulling the plate to the bone with a 3.5 cortical screw (A-5901.xx) is recommended.

Step 2 and 3

Insert a 2.0 mm K-wire (A-5040.61 or A-5042.61) or 2.0 mm olive K-wire (A-5045.61-67) bicortically through the K-wire slot (distal) into the navicular.

Insert an additional 2.0 mm K-wire or 2.0 mm olive K-wire bicortically through the K-wire hole into the talus.

Step 4

To apply compression, use the compression forceps (A-2044) with the K-wires placed in the talus and navicular.

Compression is achieved from the talus to the navicular.

Step 5

To keep the compression, fix the plate with at least one 3.5 cortical or TriLock screw in the navicular.

The K-wire or olive K-wire in the K-wire hole in the talus can be removed.

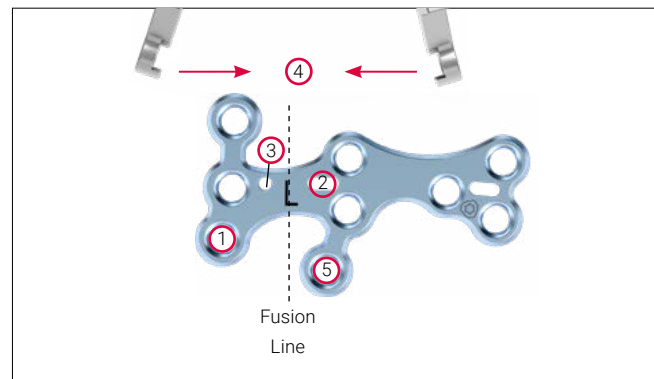

Steps 1-5

2. Fusion of the naviculocuneiform joint

Step 6

Insert an additional 2.0 mm K-wire or 2.0 mm olive K-wire bicortically through the K-wire slot (distal) into the medial cuneiform.

Step 7

To apply compression, use the compression forceps (A-2044) with the K-wires placed in the navicular and the medial cuneiform.

Compression is achieved from the navicular to the medial cuneiform.

Step 8

To keep the compression, fix the plate with at least one 3.5 cortical or TriLock screw in the medial cuneiform.

The K-wires or olive K-wires in the K-wire slots in the navicular and medial cuneiform can be removed.

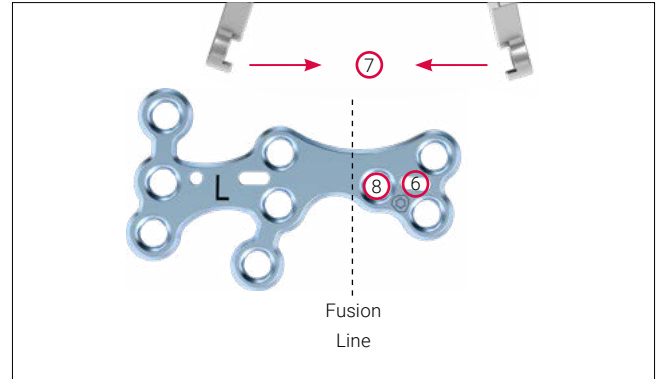

Steps 6–8

3. Fixing the plate

Fill the remaining screw holes for final fixation of the plate.

TriLock NCM Fusion Plates

(A-4960.23/24/33/34/43/44)

TriLock Distal Medial Column Fusion Plates

(A-4960.03S-04S)

Naviculocuneiform and tarsometatarsal-1 joint

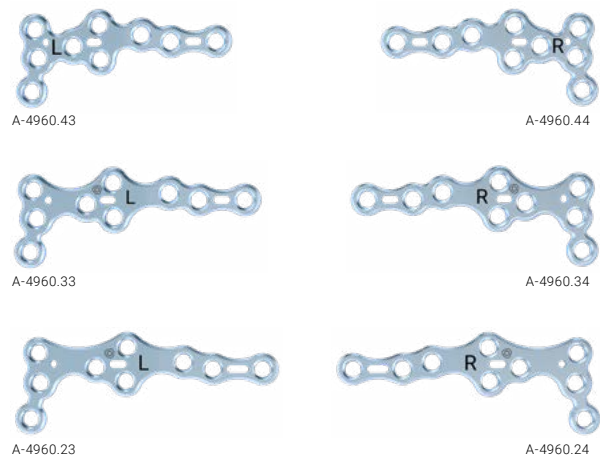
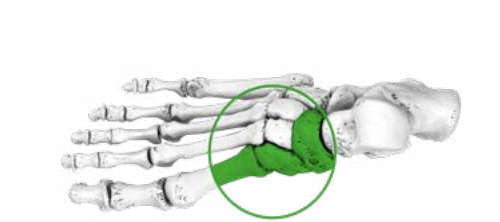

1. Fusion of the naviculocuneiform joint

Step 1

Fix the plate with a minimum of one screw in the navicular. Pulling the plate to the bone with a 3.5 cortical screw (A-5901.xx) is recommended.

Step 2 and 3

Insert a 2.0 mm K-wire (A-5040.61 or A-5042.61) or 2.0 mm olive K-wire (A-5045.61-67) bicortically through the K-wire slot (distal) into the medial cuneiform. Insert an additional 2.0 mm K-wire or 2.0 mm olive K-wire bicortically through the K-wire hole in the navicular.

Step 4

To apply compression, use the compression forceps (A-2044) with the K-wires placed in the navicular and the medial cuneiform. Compression is achieved from the navicular to the medial cuneiform.

Step 5

To keep the compression, fix the plate with at least one 3.5 cortical or TriLock screw in the medial cuneiform.

The K-wire or olive K-wire in the K-wire hole in the navicular can be removed.

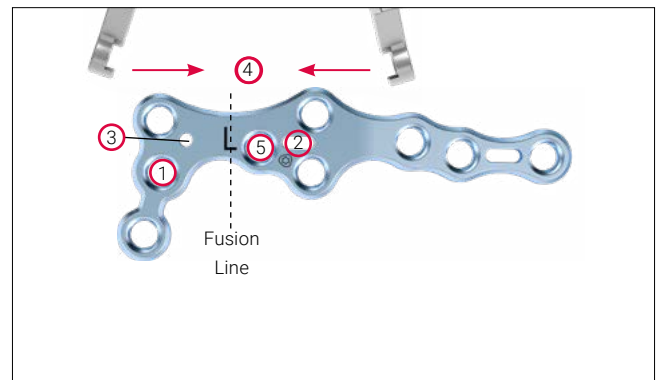

Steps 1-5

2. Fusion of the tarsometatarsal-1 joint

Step 6

Insert an additional 2.0 mm K-wire or 2.0 mm olive K-wire bicortically through the K-wire slot (distal) into the MT1.

Step 7

To apply compression, use the compression forceps (A-2044) with the K-wires placed in the medial cuneiform and MT1.

Compression is achieved from the medial cuneiform to the MT1.

Step 8

To keep the compression, fix the plate with at least one 3.5 cortical or TriLock screw in the MT1.

The K-wires or olive K-wires in the medial cuneiform and MT1 can be removed.

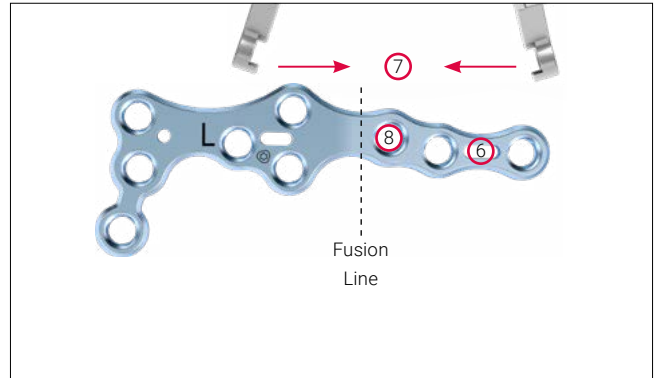

Steps 6–8

3. Fixing the plate

Fill the remaining screw holes for final fixation of the plate.

TriLock TNCM Fusion Plates

(A-4960.25/26/35/36/45/46)

TriLock Medial Column Fusion Plates

(A-4960.05S-06S)

Talonavicular, naviculocuneiform and tarsometatarsal-1 joint

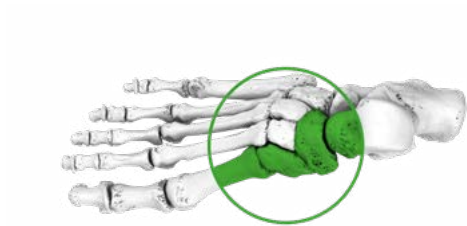

A-4960.45



A-4960.46



A-4960.35



A-4960.36



A-4960.25



A-4960.26

1. Fusion of the talonavicular joint

Step 1

Fix the plate with a minimum of one screw in the talus. Pulling the plate to the bone with a 3.5 cortical screw (A-5901.xx) is recommended.

Step 2 and 3

Insert a 2.0 mm K-wire (A-5040.61 or A-5042.61) or 2.0 mm olive K-wire (A-5045.61-67) bicortically through the K-wire slot (distal) into the navicular. Insert an additional 2.0 mm K-wire or 2.0 mm olive K-wire bicortically through the K-wire hole into the talus.

Step 4

To apply compression, use the compression forceps (A-2044) with the K-wires placed in the talus and navicular.

Compression is achieved from the talus to the navicular.

Step 5

To keep the compression, fix the plate with at least one 3.5 cortical or TriLock screw in the navicular.

The K-wire or olive K-wire in the K-wire hole in the talus can be removed.

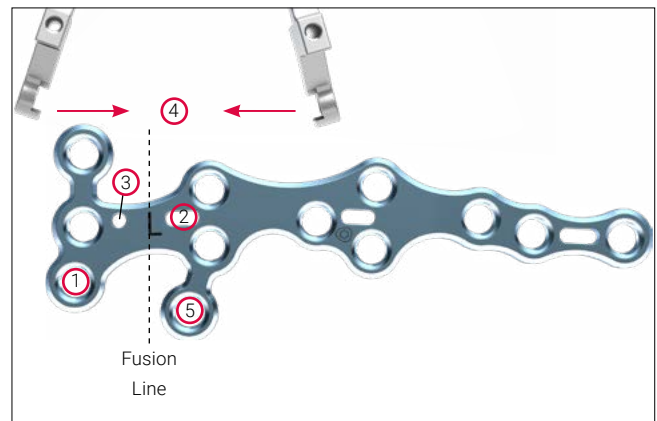

Steps 1-5

2. Fusion of the naviculocuneiform joint

Step 6

Insert an additional 2.0 mm K-wire or 2.0 mm olive K-wire bicortically through the K-wire slot (distal) into the medial cuneiform.

Step 7

To apply compression, use the compression forceps (A-2044) with the K-wires placed in the navicular and the medial cuneiform.

Compression is achieved from the navicular to the medial cuneiform.

Step 8

To keep the compression, fix the plate with at least one 3.5 cortical or TriLock screw in the medial cuneiform.

The K-wire or olive K-wire in the K-wire slot in the navicular can be removed.

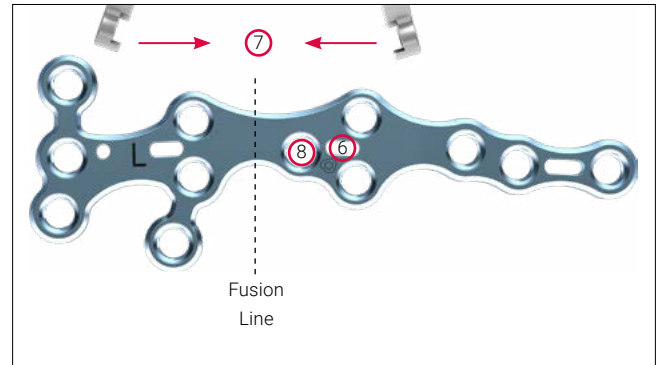

Steps 6–8

3. Fusion of the first tarsometatarsal joint

Step 9

Insert an additional 2.0 mm K-wire or 2.0 mm olive K-wire bicortically through the K-wire slot (distal) into the MT1.

Step 10

To apply compression, use the compression forceps (A-2044) with the K-wires placed in the medial cuneiform and the MT1.

Compression is achieved from the medial cuneiform to the MT1.

Step 11

To keep the compression, fix the plate with at least one 3.5 cortical or TriLock screw in the MT1.

The K-wires or olive K-wires in the slots in the medial cuneiform and MT1 can be removed.

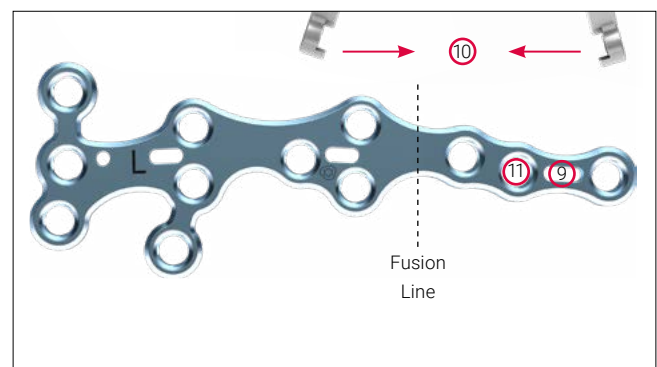

Steps 9–11

4. Fixing the plate

Fill the remaining screw holes for final fixation of the plate.

TriLock Talonavicular Fusion Plates

(A-4960.11–14)

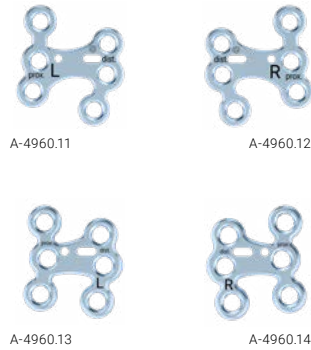

1. Fusion of the talonavicular joint

Step 1

Fix the plate with a minimum of one screw in the talus. Pulling the plate to the bone with a 3.5 cortical screw (A-5901.xx) is recommended.

Step 2 and 3

Insert a 2.0 mm K-wire (A-5040.61 or A-5042.61) or 2.0 mm olive K-wire (A-5045.61–67) bicortically through the K-wire slot (distal) into the navicular.

Insert an additional 2.0 mm K-wire or 2.0 mm olive K-wire through the K-wire hole into the talus.

Step 4

To apply compression, use the compression forceps (A-2044) with the K-wires placed in the talus and navicular.

Compression is achieved from the talus to the navicular.

Step 5

To keep the compression, fix the plate with at least one 3.5 cortical or TriLock screw in the navicular.

The K-wires or olive K-wires in the talus and navicular can be removed.

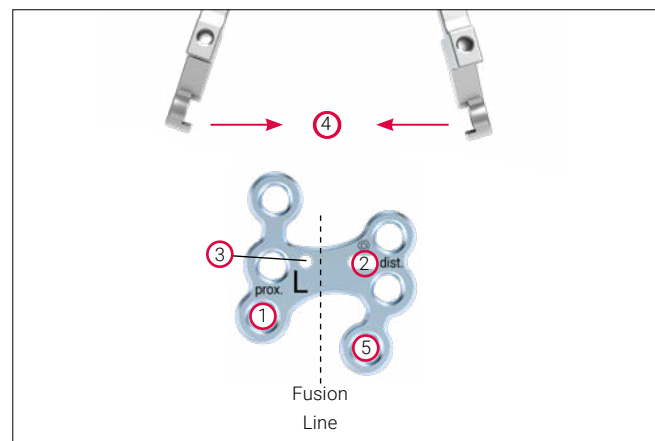

Steps 1–5

2. Fixing the plate

Fill the remaining screw holes for final fixation of the plate.

Explantation

Explantation of Fusion Plates

1. Removing the screws

Unlock all screws and remove them.

The order in which the screws are removed is not relevant.

In case the plate sticks to the bone, use a periosteal elevator to carefully lift and detach it from the bone.

Caution

When removing the screws, ensure that any bone ingrowth in the screw head has been removed, that the screwdriver / screw head connection is aligned in axial direction, and that a sufficient axial force is used between blade and screw.

TriLock Locking Technology

Correct Application of the TriLock Locking Technology

The screw is inserted through the plate hole into a predrilled canal in the bone. An increase of the tightening torque will be felt as soon as the screw head gets in contact with the plate surface.

This indicates the start of the "Insertion Phase" as the screw head starts entering the locking zone of the plate (section "A" in the diagram). Afterwards, a drop of the tightening torque

occurs (section "B" in the diagram). Finally the actual locking is initiated (section "C" in the diagram) as a friction connection is established between screw and plate when tightening firmly.

The torque applied during fastening of the screw is decisive for the quality of the locking as described in section "C" of the diagram.

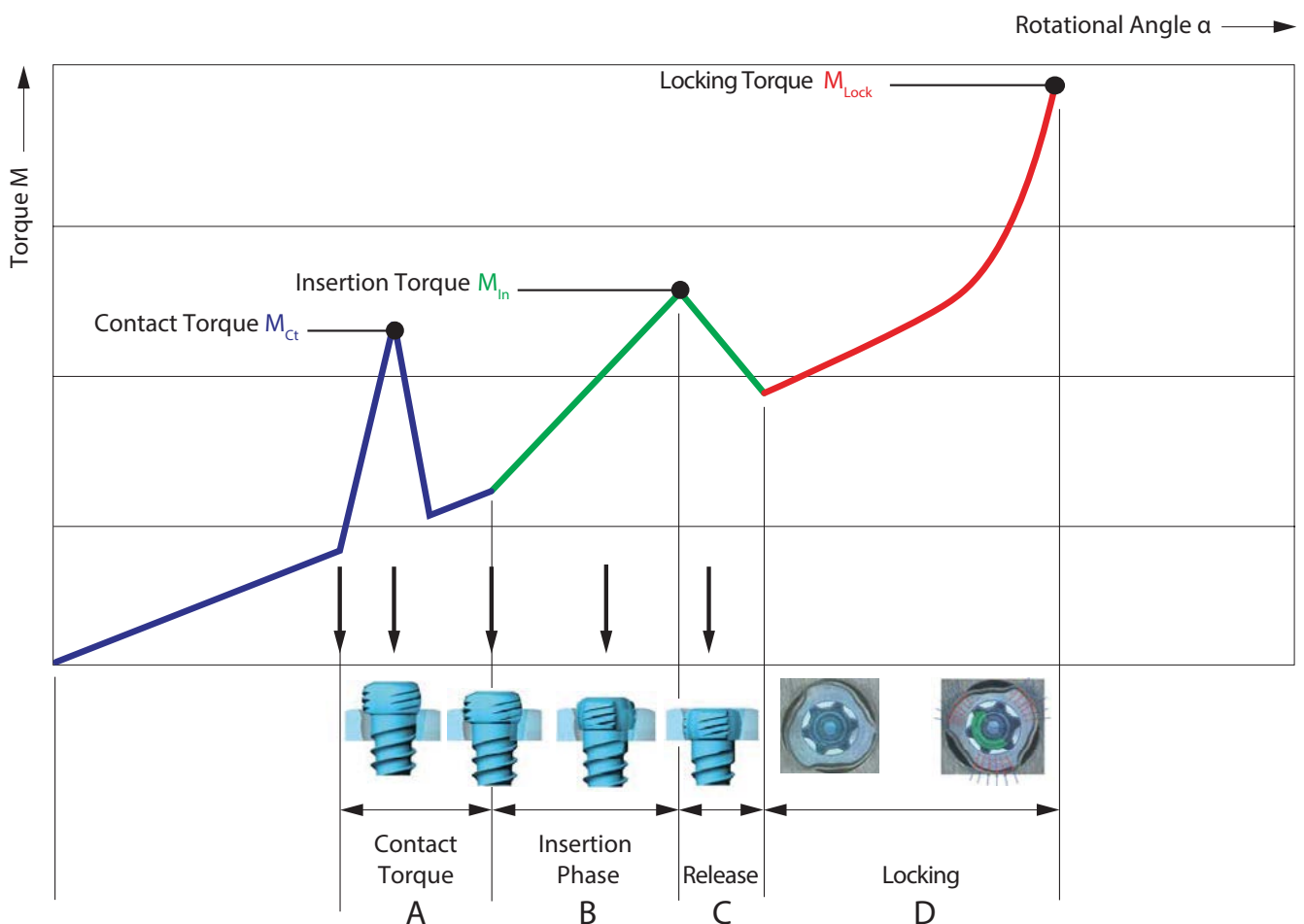

Correct Locking ($\pm 15^\circ$) of the TriLock Screws in the Fusion System 3.5

Correct locking occurs only when the screw head is locked flush with the locking contour (fig. 1 and 3).

However, if there is still a noticeable protrusion (fig. 2 and 4), the screw head has not completely reached the locking position. In this case, the screw has to be retightened to obtain full penetration and proper locking. In case of poor bone

quality, a slight axial pressure may be necessary to achieve proper locking.

After having reached the locking torque (M_{Lock}), do not further tighten the screw, otherwise the locking function cannot be guaranteed anymore.

Correct: LOCKED

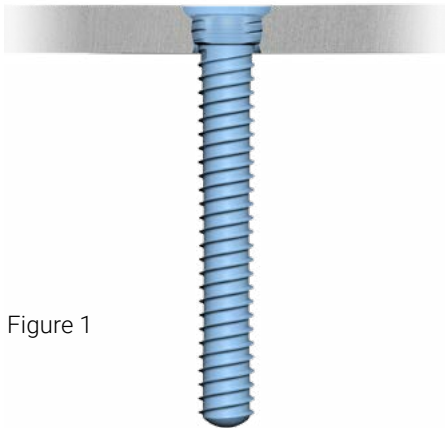

Figure 1

Incorrect: UNLOCKED

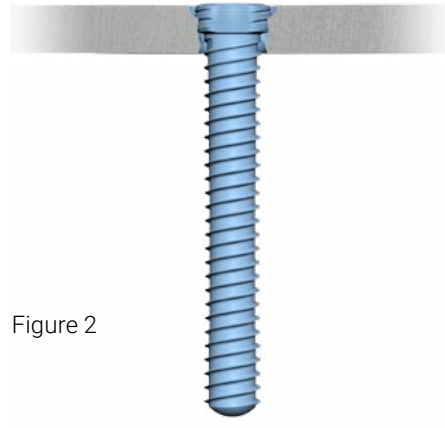

Figure 2

Correct: LOCKED

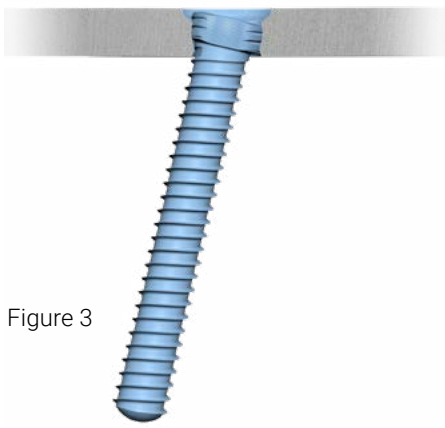

Figure 3

Incorrect: UNLOCKED

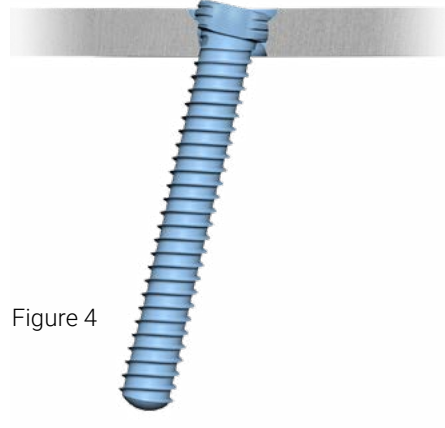

Figure 4

Implants, Instruments and Containers

3.5 Cortical Screws, HexaDrive 15

Material: Titanium alloy (ASTM F136)



| Length | Art. No. | STERILE | Pieces / Pkg |
|--------|-------------|--------------|--------------|
| 10 mm | A-5901.10/1 | A-5901.10/1S | 1 |
| 12 mm | A-5901.12/1 | A-5901.12/1S | 1 |
| 14 mm | A-5901.14/1 | A-5901.14/1S | 1 |
| 16 mm | A-5901.16/1 | A-5901.16/1S | 1 |
| 18 mm | A-5901.18/1 | A-5901.18/1S | 1 |
| 20 mm | A-5901.20/1 | A-5901.20/1S | 1 |
| 22 mm | A-5901.22/1 | A-5901.22/1S | 1 |
| 24 mm | A-5901.24/1 | A-5901.24/1S | 1 |
| 26 mm | A-5901.26/1 | A-5901.26/1S | 1 |
| 28 mm | A-5901.28/1 | A-5901.28/1S | 1 |
| 30 mm | A-5901.30/1 | A-5901.30/1S | 1 |
| 32 mm | A-5901.32/1 | A-5901.32/1S | 1 |
| 34 mm | A-5901.34/1 | A-5901.34/1S | 1 |
| 36 mm | A-5901.36/1 | A-5901.36/1S | 1 |
| 38 mm | A-5901.38/1 | A-5901.38/1S | 1 |
| 40 mm | A-5901.40/1 | A-5901.40/1S | 1 |
| 45 mm | A-5901.45/1 | A-5901.45/1S | 1 |
| 50 mm | A-5901.50/1 | A-5901.50/1S | 1 |
| 55 mm | A-5901.55/1 | A-5901.55/1S | 1 |
| 60 mm | A-5901.60/1 | A-5901.60/1S | 1 |

3.5 TriLock Screws, HexaDrive 15

Material: Titanium alloy (ASTM F136)

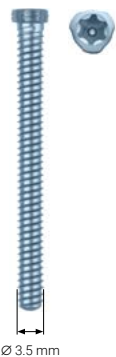

| Length | Art. No. | STERILE | Pieces / Pkg |
|--------|-------------|--------------|--------------|
| 10 mm | A-5950.10/1 | A-5950.10/1S | 1 |
| 12 mm | A-5950.12/1 | A-5950.12/1S | 1 |
| 14 mm | A-5950.14/1 | A-5950.14/1S | 1 |
| 16 mm | A-5950.16/1 | A-5950.16/1S | 1 |
| 18 mm | A-5950.18/1 | A-5950.18/1S | 1 |
| 20 mm | A-5950.20/1 | A-5950.20/1S | 1 |
| 22 mm | A-5950.22/1 | A-5950.22/1S | 1 |
| 24 mm | A-5950.24/1 | A-5950.24/1S | 1 |
| 26 mm | A-5950.26/1 | A-5950.26/1S | 1 |
| 28 mm | A-5950.28/1 | A-5950.28/1S | 1 |
| 30 mm | A-5950.30/1 | A-5950.30/1S | 1 |
| 32 mm | A-5950.32/1 | A-5950.32/1S | 1 |
| 34 mm | A-5950.34/1 | A-5950.34/1S | 1 |
| 36 mm | A-5950.36/1 | A-5950.36/1S | 1 |
| 38 mm | A-5950.38/1 | A-5950.38/1S | 1 |
| 40 mm | A-5950.40/1 | A-5950.40/1S | 1 |
| 45 mm | A-5950.45/1 | A-5950.45/1S | 1 |
| 50 mm | A-5950.50/1 | A-5950.50/1S | 1 |
| 55 mm | A-5950.55/1 | A-5950.55/1S | 1 |
| 60 mm | A-5950.60/1 | A-5950.60/1S | 1 |

4.0 Cancellous Screws, HexaDrive 15

Material: Titanium alloy (ASTM F136)



| Length | Art. No. | STERILE | Pieces / Pkg |
|--------|-------------|--------------|--------------|
| 10 mm | A-5990.10/1 | A-5990.10/1S | 1 |
| 12 mm | A-5990.12/1 | A-5990.12/1S | 1 |
| 14 mm | A-5990.14/1 | A-5990.14/1S | 1 |
| 16 mm | A-5990.16/1 | A-5990.16/1S | 1 |
| 18 mm | A-5990.18/1 | A-5990.18/1S | 1 |
| 20 mm | A-5990.20/1 | A-5990.20/1S | 1 |
| 22 mm | A-5990.22/1 | A-5990.22/1S | 1 |
| 24 mm | A-5990.24/1 | A-5990.24/1S | 1 |
| 26 mm | A-5990.26/1 | A-5990.26/1S | 1 |
| 28 mm | A-5990.28/1 | A-5990.28/1S | 1 |
| 30 mm | A-5990.30/1 | A-5990.30/1S | 1 |
| 32 mm | A-5990.32/1 | A-5990.32/1S | 1 |
| 34 mm | A-5990.34/1 | A-5990.34/1S | 1 |
| 36 mm | A-5990.36/1 | A-5990.36/1S | 1 |
| 38 mm | A-5990.38/1 | A-5990.38/1S | 1 |
| 40 mm | A-5990.40/1 | A-5990.40/1S | 1 |
| 45 mm | A-5990.45/1 | A-5990.45/1S | 1 |
| 50 mm | A-5990.50/1 | A-5990.50/1S | 1 |
| 55 mm | A-5990.55/1 | A-5990.55/1S | 1 |
| 60 mm | A-5990.60/1 | A-5990.60/1S | 1 |

3.5 TriLock Wing Plates

Material: Titanium (ASTM F67)
Plate thickness: 2.0 mm

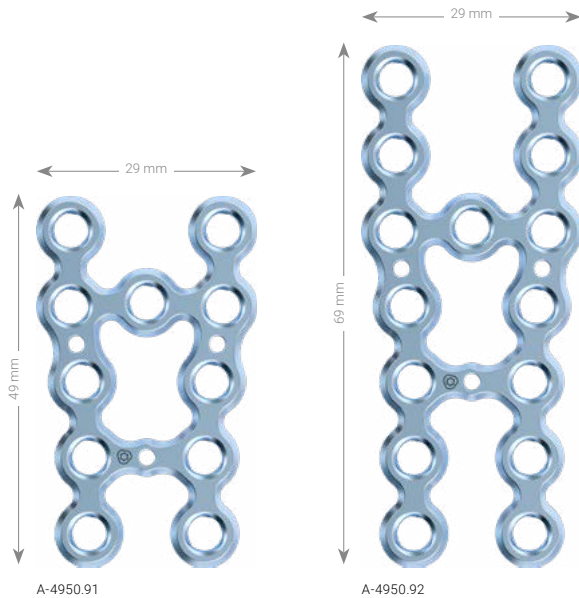

| Art. No. | STERILE | Template | Description | Pieces / Pkg |
|-----------|------------|-------------|-------------|--------------|
| A-4950.91 | A-4950.91S | A-4950.91TP | small | 1 |
| A-4950.92 | A-4950.92S | A-4950.92TP | large | 1 |

3.5 TriLock Butterfly Plates

Material: Titanium (ASTM F67)
Plate thickness: 2.0 mm

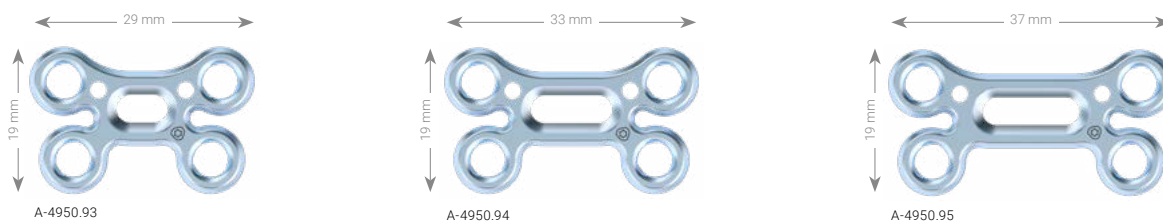

| Art. No. | STERILE | Template | Description | Pieces / Pkg |
|-----------|------------|-------------|-------------|--------------|
| A-4950.93 | A-4950.93S | A-4950.93TP | small | 1 |
| A-4950.94 | A-4950.94S | A-4950.94TP | medium | 1 |
| A-4950.95 | A-4950.95S | A-4950.95TP | large | 1 |

3.5 TriLock TNC Fusion Plates

Material: Titanium (ASTM F67)
Plate thickness: 2.0 mm

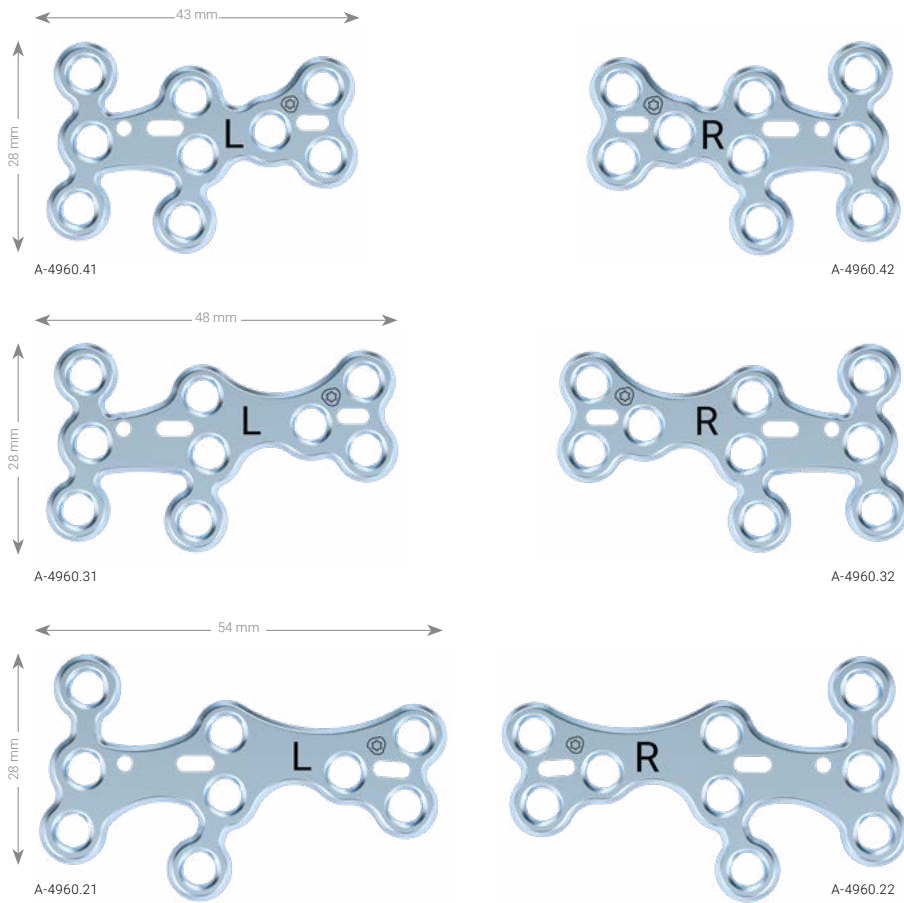

| Art. No. | STERILE | Template | Description | Pieces / Pkg |
|-----------|----------------|-------------|---------------|--------------|
| A-4960.21 | A-4960.21S | A-4960.21TP | large, left | 1 |
| A-4960.22 | A-4960.22S | A-4960.22TP | large, right | 1 |
| A-4960.31 | A-4960.31S | A-4960.31TP | medium, left | 1 |
| A-4960.32 | A-4960.32S | A-4960.32TP | medium, right | 1 |
| A-4960.41 | A-4960.41S | A-4960.41TP | small, left | 1 |
| A-4960.42 | A-4960.42S | A-4960.42TP | small, right | 1 |

3.5 TriLock Proximal Medial Column Fusion Plates

Material: Titanium (ASTM F136)
Plate thickness: 2.5 mm

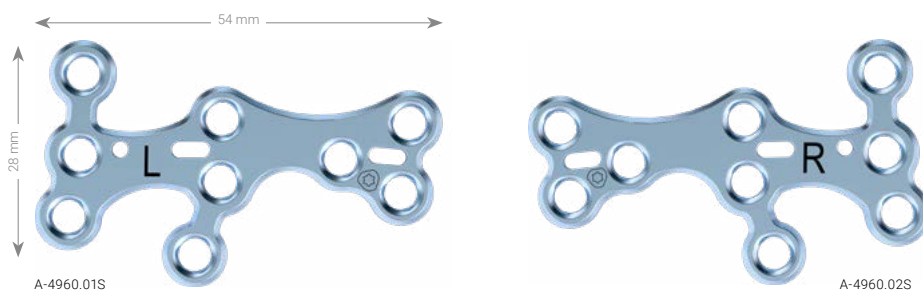

| Art. No. | STERILE | Description | Pieces / Pkg |
|----------|----------------|--------------|--------------|
| | A-4960.01S | large, left | 1 |
| | A-4960.02S | large, right | 1 |

3.5 TriLock NCM Fusion Plates

Material: Titanium (ASTM F67)
Plate thickness: 2.0 mm

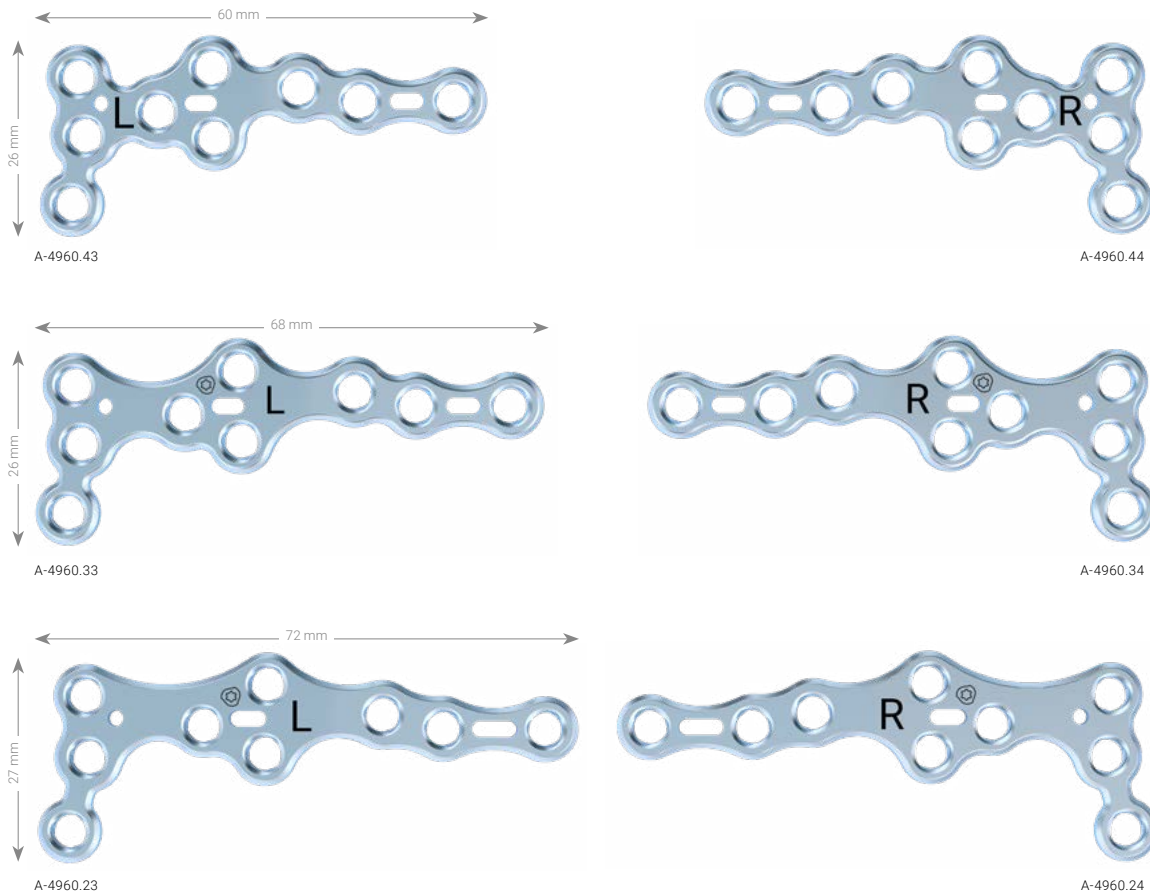

| Art. No. | STERILE | Template | Description | Pieces / Pkg |
|-----------|------------|-------------|---------------|--------------|
| A-4960.23 | A-4960.23S | A-4960.23TP | large, left | 1 |
| A-4960.24 | A-4960.24S | A-4960.24TP | large, right | 1 |
| A-4960.33 | A-4960.33S | A-4960.33TP | medium, left | 1 |
| A-4960.34 | A-4960.34S | A-4960.34TP | medium, right | 1 |
| A-4960.43 | A-4960.43S | A-4960.43TP | small, left | 1 |
| A-4960.44 | A-4960.44S | A-4960.44TP | small, right | 1 |

3.5 TriLock Distal Medial Column Fusion Plates

Material: Titanium (ASTM F136)
Plate thickness: 2.5 mm

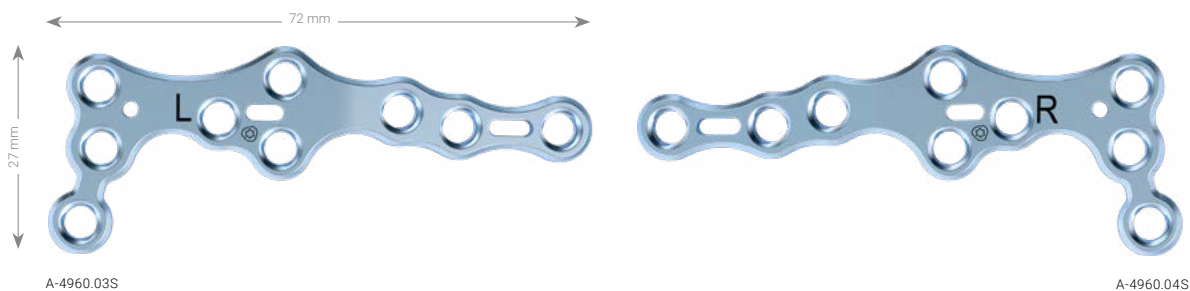

| Art. No. | STERILE | Description | Pieces / Pkg |
|------------|---------|--------------|--------------|
| A-4960.03S | | large, left | 1 |
| A-4960.04S | | large, right | 1 |

3.5 TriLock TNCM Fusion Plates

Material: Titanium (ASTM F67)
Plate thickness: 2.0 mm

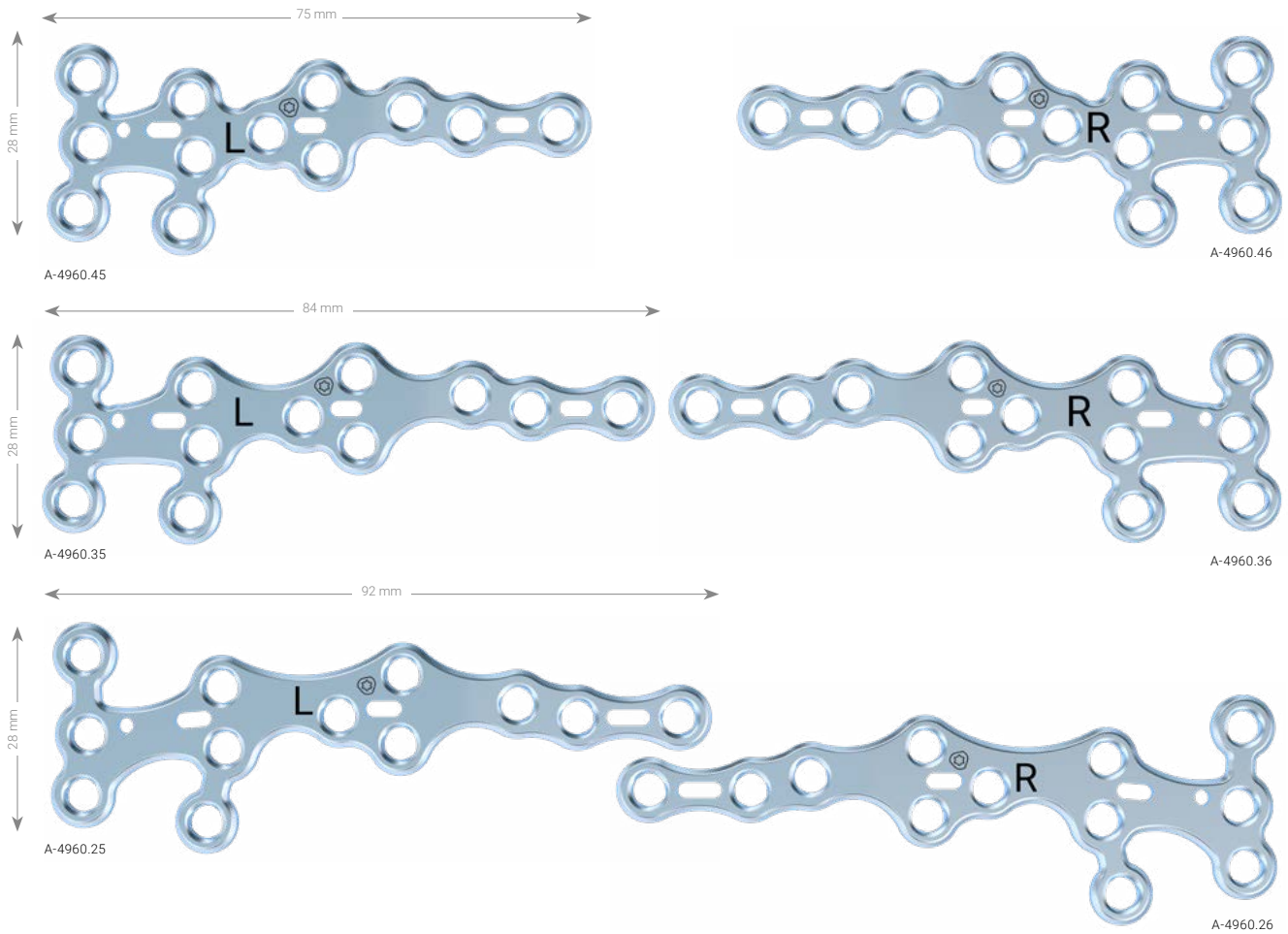

| Art. No. | STERILE | Template | Description | Pieces / Pkg |
|-----------|----------------|-------------|---------------|--------------|
| A-4960.35 | A-4960.35S | A-4960.35TP | medium, left | 1 |
| A-4960.36 | A-4960.36S | A-4960.36TP | medium, right | 1 |
| A-4960.45 | A-4960.45S | A-4960.45TP | small, left | 1 |
| A-4960.46 | A-4960.46S | A-4960.46TP | small, right | 1 |
| A-4960.25 | A-4960.25S | A-4960.25TP | large, left | 1 |
| A-4960.26 | A-4960.26S | A-4960.26TP | large, right | 1 |

3.5 TriLock Medial Column Fusion Plates

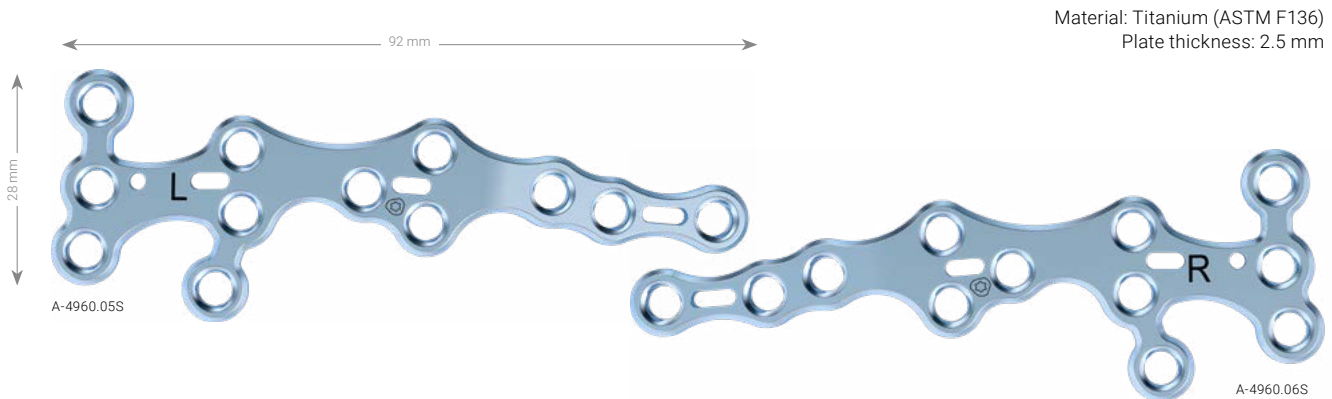

| Art. No. | STERILE | Description | Pieces / Pkg |
|------------|---------|--------------|--------------|
| A-4960.05S | | large, left | 1 |
| A-4960.06S | | large, right | 1 |

3.5 TriLock Talonavicular Fusion Plates

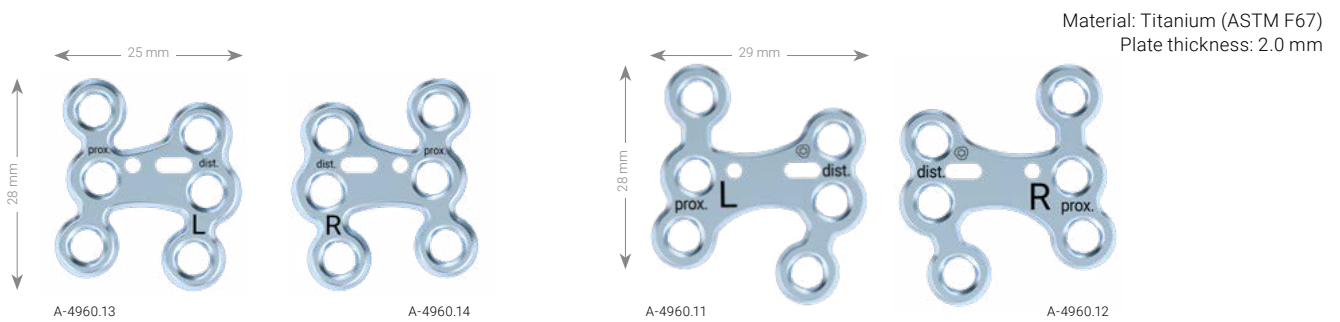

| Art. No. | STERILE | Template | Description | Pieces / Pkg |
|-----------|------------|-------------|--------------|--------------|
| A-4960.11 | A-4960.11S | A-4960.11TP | large, left | 1 |
| A-4960.12 | A-4960.12S | A-4960.12TP | large, right | 1 |
| A-4960.13 | A-4960.13S | A-4960.13TP | small, left | 1 |
| A-4960.14 | A-4960.14S | A-4960.14TP | small, right | 1 |

Plate Holding and Positioning Instrument



| Art. No. | System Size | Length | Pieces / Pkg |
|----------|-------------|--------|--------------|
| A-2950 | 2.8 / 3.5 | 178 mm | 1 |

Twist Drill Ø 2.6 mm (for Cortical Screws)



| Art. No. | STERILE | System Size | Stop | Length | Shaft End | Pieces / Pkg |
|----------|---------|-------------|-------|--------|-------------------|--------------|
| A-3934 | A-3934S | 3.5 | 70 mm | 150 mm | AO Quick Coupling | 1 |

Twist Drill Ø 3.0 mm



| Art. No. | STERILE | System Size | Stop | Length | Shaft End | Pieces / Pkg |
|----------|---------|-------------|-------|--------|-------------------|--------------|
| A-3931 | A-3931S | 3.5 | 70 mm | 150 mm | AO Quick Coupling | 1 |

Twist Drill Ø 3.6 mm (for Gliding Hole)



| Art. No. | STERILE | System Size | Stop | Length | Shaft End | Pieces / Pkg |
|----------|---------|-------------|-------|--------|-------------------|--------------|
| A-3933 | A-3933S | 3.5 | 30 mm | 126 mm | AO Quick Coupling | 1 |

Countersink (for Cortical Screws)



| Art. No. | System Size | Ø | Stop | Shaft End | Pieces / Pkg |
|----------|-------------|--------|-------|-------------------|--------------|
| A-3930 | 3.5 | 6.0 mm | 45 mm | AO Quick Coupling | 1 |

K-Wires, Stainless Steel



| Art. No. | STERILE | ∅ | Description | Length | Pieces / Pkg |
|-------------|--------------|--------|-------------|--------|--------------|
| A-5040.61 | | 2.0 mm | trocar | 150 mm | 10 |
| A-5040.61/1 | | 2.0 mm | trocar | 150 mm | 1 |
| | A-5040.61/2S | 2.0 mm | trocar | 150 mm | 2 |
| A-5042.61 | | 2.0 mm | lancet | 150 mm | 10 |
| A-5042.61/1 | | 2.0 mm | lancet | 150 mm | 1 |
| | A-5042.61/2S | 2.0 mm | lancet | 150 mm | 2 |

Olive K-Wires, Stainless Steel

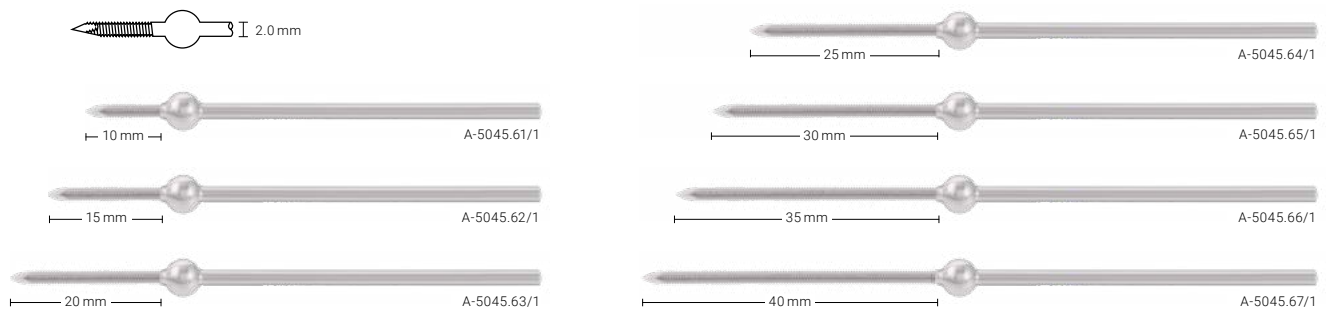

| Art. No. | STERILE | ∅ | Thread Length | Length | Pieces / Pkg |
|-------------|--------------|--------|---------------|--------|--------------|
| A-5045.61/1 | | 2.0 mm | 10 mm | 60 mm | 1 |
| | A-5045.61/2S | 2.0 mm | 10 mm | 60 mm | 2 |
| A-5045.62/1 | | 2.0 mm | 15 mm | 65 mm | 1 |
| | A-5045.62/2S | 2.0 mm | 15 mm | 65 mm | 2 |
| A-5045.63/1 | | 2.0 mm | 20 mm | 70 mm | 1 |
| | A-5045.63/2S | 2.0 mm | 20 mm | 70 mm | 2 |
| A-5045.64/1 | | 2.0 mm | 25 mm | 75 mm | 1 |
| | A-5045.64/2S | 2.0 mm | 25 mm | 75 mm | 2 |
| A-5045.65/1 | | 2.0 mm | 30 mm | 80 mm | 1 |
| | A-5045.65/2S | 2.0 mm | 30 mm | 80 mm | 2 |
| A-5045.66/1 | | 2.0 mm | 35 mm | 85 mm | 1 |
| | A-5045.66/2S | 2.0 mm | 35 mm | 85 mm | 2 |
| A-5045.67/1 | | 2.0 mm | 40 mm | 90 mm | 1 |
| | A-5045.67/2S | 2.0 mm | 40 mm | 90 mm | 2 |

Drill Guides



| Art. No. | System Size | ∅ | Description | Length | Pieces / Pkg |
|----------|-------------|--------------|---|--------|--------------|
| A-2925 | 3.5 | 2.6 / 3.6 mm | for cortical screws (core and gliding hole) | 171 mm | 1 |
| A-2927 | 3.5 | 3.0 mm | for TriLock screws | 126 mm | 1 |

Drill Sleeve



| Art. No. | System Size | Description | Length | Pieces / Pkg |
|----------|-------------|--------------|--------|--------------|
| A-2921 | 3.5 | self-holding | 50 mm | 1 |

Depth Gauge



| Art. No. | System Size | Description | Length | Pieces / Pkg |
|----------|-------------|-------------|--------|--------------|
| A-2931 | 3.5 / 4.0 | 10-70 mm | 211 mm | 1 |

Handles with Quick Connector



| Art. No. | System Size | Description | For Shaft End | Length | Pieces / Pkg |
|----------|-------------|-------------|-------------------|--------|--------------|
| A-2074 | 3.5 | | AO Quick Coupling | 145 mm | 1 |
| A-2075 | 3.5 | T-handle | AO Quick Coupling | 81 mm | 1 |

Screwdriver Blade, Self-Holding



| Art. No. | System Size | Interface | Shaft End | Length | Pieces / Pkg |
|----------|-------------|-----------|-------------------|--------|--------------|
| A-2911 | 3.5 / 4.0 | HD15 | AO Quick Coupling | 80 mm | 1 |

Plate Cutting Pliers

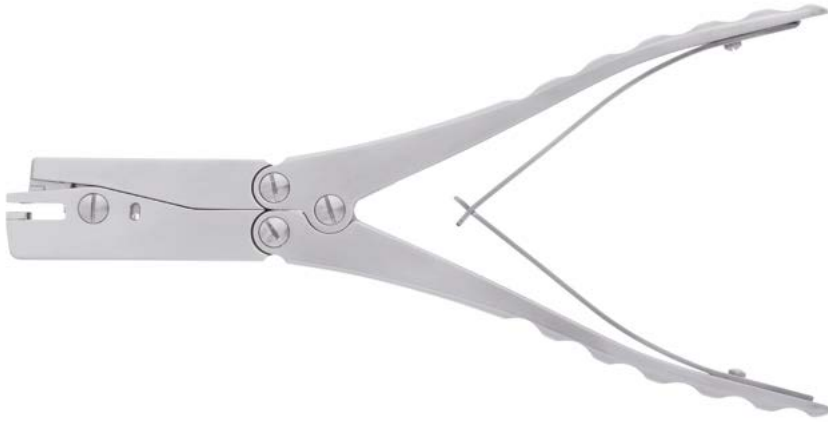

| Art. No. | System Size | Length | Pieces / Pkg |
|----------|-------------|--------|--------------|
| A-2045 | 2.0-3.5 | 218 mm | 1 |

Plate Bending Pliers



| Art. No. | System Size | Length | Pieces / Pkg |
|----------|-------------|--------|--------------|
| A-2940 | 3.5 / 4.0 | 158 mm | 1 |

Compression Forceps

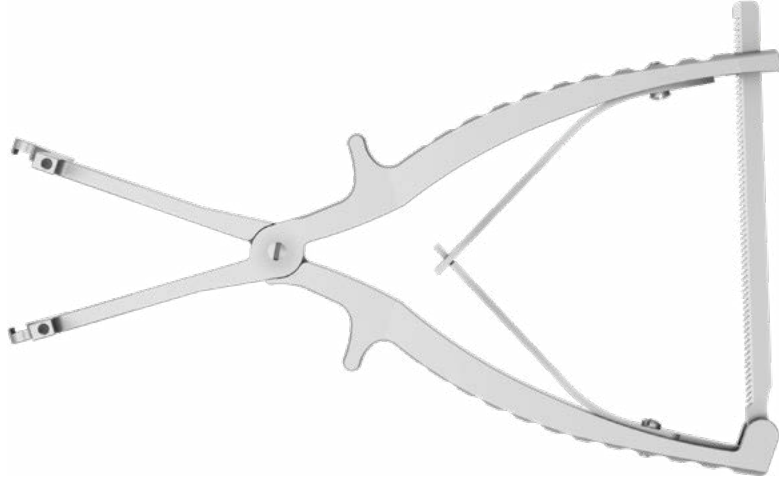

| Art.No. | Description | Length | Pieces / Pkg |
|---------|----------------------|--------|--------------|
| A-2044 | for K-wires Ø 2.0 mm | 205 mm | 1 |

K-Wire Spreader

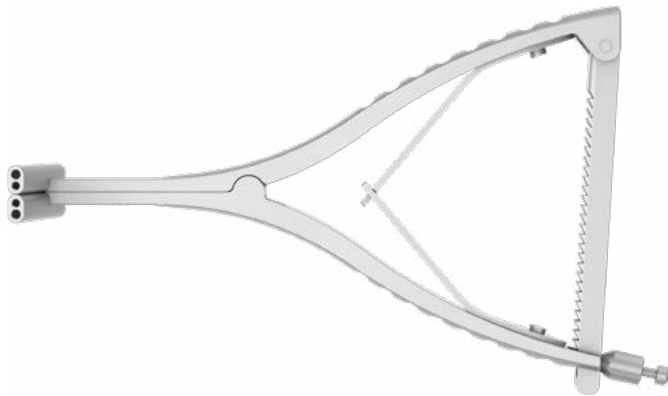

| Art. No. | Description | Length | Pieces / Pkg |
|----------|--------------|--------|--------------|
| A-2056 | for Ø 2.0 mm | 175 mm | 1 |

Lamina Spreader

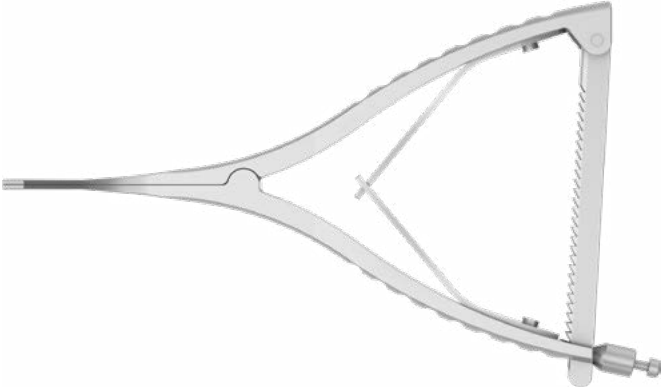

| Art. No. | Length | Pieces / Pkg |
|----------|--------|--------------|
| A-7019 | 174 mm | 1 |

Bone Elevator Mini-Hohmann



| Art. No. | Width | Length | Pieces / Pkg |
|----------|-------|--------|--------------|
| A-7006 | 8 mm | 160 mm | 1 |

Periosteal Elevator



| Art. No. | Width | Length | Pieces / Pkg |
|----------|-------|--------|--------------|
| A-7007 | 6 mm | 185 mm | 1 |

Reduction Forceps

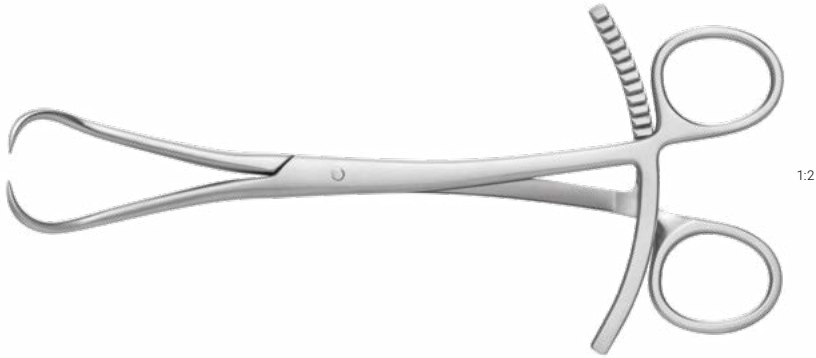

1:2

| Art. No. | Length | Pieces / Pkg |
|----------|--------|--------------|
| A-7014 | 205 mm | 1 |

Cases, Trays

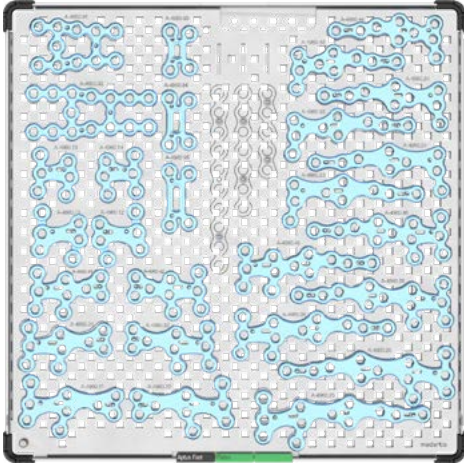

A-6601.092 containing A-6601.093
(excl. implants)

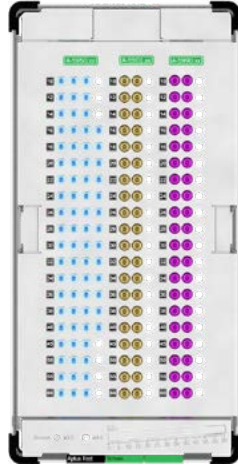

A-6601.037 containing A-6601.071
(excl. screws)

| Art. No. | Description | Dimensions (W x L) | Pieces / Pkg |
|------------|---|--------------------|--------------|
| A-6601.037 | implant case APTUS Foot screws 3.5 | 120 x 240 mm | 1 |
| A-6601.071 | screw tray APTUS Foot 3.5 | 114 x 232 mm | 1 |
| A-6601.092 | implant case APTUS Foot plates 3.5 | 240 x 240 mm | 1 |
| A-6601.093 | plate tray APTUS Foot 3.5 | 234 x 234 mm | 1 |
| M-6726 | lid for implant and instrument case 120 x 240mm | 120 x 240 mm | 1 |
| M-6727 | lid for implant and instrument case 240 x 240mm | 240 x 240 mm | 1 |

Additional configurations available on request.

Cases, Trays

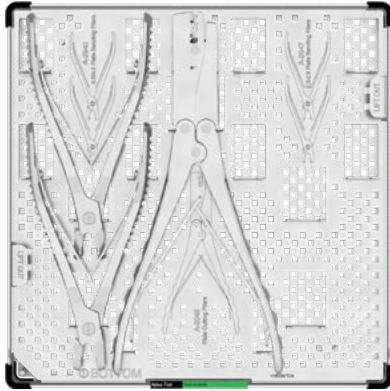

A-6601.081 containing A-6601.082
(excl. instruments)

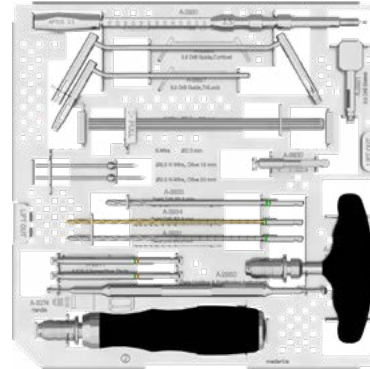

A-6601.083
(excl. instruments)

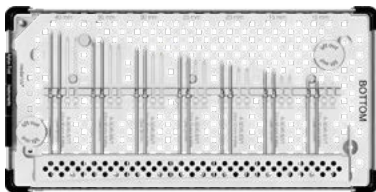

A-6601.038 with A-6601.020
(excl. olive K-wires)

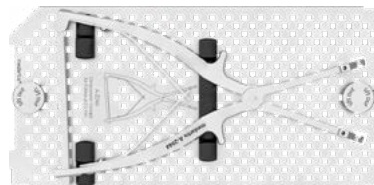

A-6601.021
(excl. instrument)



A-6601.065 with A-6601.064
(excl. instruments)



A-6601.063
(excl. instruments)

| Art. No. | Description | Dimensions (W x L) | Pieces / Pkg |
|------------|---|--------------------|--------------|
| A-6601.020 | instrument tray APTUS Foot | 114 x 234 mm | 1 |
| A-6601.021 | instrument tray APTUS Foot | 114 x 234 mm | 1 |
| A-6601.038 | implant case APTUS Foot olive K-wires | 120 x 240 mm | 1 |
| A-6601.063 | instrument tray APTUS Foot | 234 x 234 mm | 1 |
| A-6601.064 | instrument tray APTUS Foot | 234 x 234 mm | 1 |
| A-6601.065 | instrument case APTUS Foot | 240 x 240 mm | 1 |
| A-6601.081 | instrument case APTUS Foot 3.5 | 240 x 240 mm | 1 |
| A-6601.082 | instrument tray APTUS Foot | 234 x 234 mm | 1 |
| A-6601.083 | instrument tray APTUS Foot 3.5 | 234 x 234 mm | 1 |
| M-6726 | lid for implant and instrument case 120 x 240mm | 120 x 240 mm | 1 |
| M-6727 | lid for implant and instrument case 240 x 240mm | 240 x 240 mm | 1 |

Additional configurations available on request.

Storage and Transportation

| Art. No. | Description | Dimensions (W x L x H) | Pieces/Pkg |
|----------|---|------------------------|------------|
| M-6720 | holding rack for implant and instrument case 240 x 240 mm | 252 x 243 x 245 mm | 1 |
| M-6730 | holding rack for implant and instrument cases, 2 x 240 x 240 mm | 490 x 243 x 195 mm | 1 |

Articles available on request

| | |
|-------------|------------|
| A-2913.1 | A-6601.036 |
| A-2913.2 | A-6601.060 |
| A-4960.01 | A-6601.061 |
| A-4960.01TP | A-6601.062 |
| A-4960.02 | A-6601.089 |
| A-4960.02TP | A-6610.92 |
| A-4960.03 | A-6611 |
| A-4960.03TP | |
| A-4960.04 | |
| A-4960.04TP | |
| A-4960.05 | |
| A-4960.05TP | |
| A-4960.06 | |
| A-4960.06TP | |

R FOOT-01050001_v2 / 2023-05, Medartis AG, Switzerland. All technical data subject to alteration.

MANUFACTURER & HEADQUARTERS

Medartis AG | Hochbergerstrasse 60E | 4057 Basel / Switzerland
P +41 61 633 34 34 | F +41 61 633 34 00 | www.medartis.com

SUBSIDIARIES

Australia | Austria | Brazil | France | Germany | Japan | Mexico | New Zealand | Poland | Spain | UK | USA

For detailed information regarding our subsidiaries and distributors, please visit www.medartis.com



Disclaimer: This information is intended to demonstrate the Medartis portfolio of medical devices. A surgeon must always rely on her or his own professional clinical judgement when deciding whether to use a particular product when treating a particular patient. Medartis is not giving any medical advice. The devices may not be available in all countries due to registration and/or medical practices. For further questions, please contact your Medartis representative (www.medartis.com). This information contains products with CE and/or UKCA marking. All pictures shown are for illustration purposes only and may not be an exact representation of the product. For US only: Federal law restricts this device to sale by or on the order of a physician.

© Medartis 2023. Everything herein is protected by copyright, trademarks and other intellectual property rights, as applicable, owned by or licensed to Medartis or its affiliates unless otherwise indicated. It is forbidden to redistribute, duplicate or disclose anything herein, in whole or in part, without the prior written consent of Medartis.