

medartis

PRECISION IN FIXATION

SURGICAL TECHNIQUE

MODUS 2 Orthognathics



MODUS

Contents

3	Introduction
3	Product Materials
3	Indications
3	Contraindications
3	Color Coding
3	Possible Combination of Plates and Screws
3	Symbols
4	System Overview
8	Treatment Concept
8	LeFort I Osteotomies
9	LeFort II Osteotomies
9	LeFort III Osteotomies
10	Ramus Osteotomies
10	Sagittal Split
11	Genioplasty
12	Instrument Application
12	General Instrument Application
12	Picking up the Plates
12	Cutting the Plates
15	Bending the Plates
19	Drills
20	Drilling with Drill Guide
23	Assigning the Screw Length
24	Screw Pick-Up
26	Surgical Techniques
26	General Surgical Techniques
26	Lag Screw Technique
27	Specific Surgical Techniques
27	Fixation of a LeFort I Osteotomy
31	Fixation of a Sagittal Split with an Open, Flexible Sagittal Split Plate
34	Fixation of a Sagittal Split with a Closed, Semi-Rigid Sagittal Split Plate
37	Fixation of a Horizontal Ramus Osteotomy with the TriLock Ramus Plate
41	Genioplasty with a Pre-Shaped Chin Plate
43	Follow-Up Care and Explanation
43	Follow-Up Care for MODUS 2 Orthognathics Implants
43	Explanation of MODUS 2 Orthognathics Implants
44	TriLock Locking Technology
44	Correct Application of the TriLock Locking Technology
45	Correct Locking ($\pm 15^\circ$) of the TriLock Screws in the Plate
46	Implants, Instruments and Containers

For further information regarding the MODUS 2 product line, visit www.medartis.com.

Introduction

Product Materials

Product	Material
Plates	Pure titanium
Screws	Titanium alloy
Instruments	Stainless steel, PEEK, aluminum, Nitinol, silicone or titanium
Containers	Stainless steel, aluminum, PEEK, polyphenylsulfone, polyurethane, silicone

Indications

MODUS 2 Orthognathics is indicated for maxillary (LeFort I, II and III) and mandibular (ramus and corpus) osteotomies and genioplasties as part of orthognathic surgery and for fixation of maxillary and mandibular traumas.

Contraindications

- Preexisting or suspected infection at or near the implantation site
- Known allergies and/or hypersensitivity to implant materials
- Inferior or insufficient bone quality to securely anchor the implant
- Patients who are incapacitated and/or uncooperative during the treatment phase
- Blocking of growth plates with plates and screws
- The IMF system cannot be used in unstable, comminuted, displaced and/or bi-maxillary fractures

Color Coding

Screw Diameter	Color Code
1.2	Red
1.5	Green
1.8	Yellow
2.0	Blue
2.3	Brown

Plates and Screws

Implant plates gold	Rigid fixation plates
Implant plates blue	Semi-rigid fixation plates*
Implant plates silver	TriLock plates (locking)
Implant screws gold	Cortical screws (fixation)
Implant screws silver	TriLock screws (locking)
Implant screws green	SpeedTip screws (self-drilling)

Possible Combination of Plates and Screws

Screws and plates can be combined as follows:

Plates	Screws
Midface Plates	1.2/1.5/1.8 Cortical Screws, HexaDrive 4 1.5 SpeedTip Screws, HexaDrive 4
Mandible Plates	2.0/2.3 Cortical Screws, HexaDrive 6 2.0 SpeedTip Screws, HexaDrive 6
TriLock Ramus Plate	2.0 TriLock Screws, HexaDrive 6 2.0/2.3 Cortical Screws, HexaDrive 6 2.0 SpeedTip Screws, HexaDrive 6

Symbols



HexaDrive





SpeedTip





* Semi-rigid is easier to form than rigid materials with the same plate geometry.



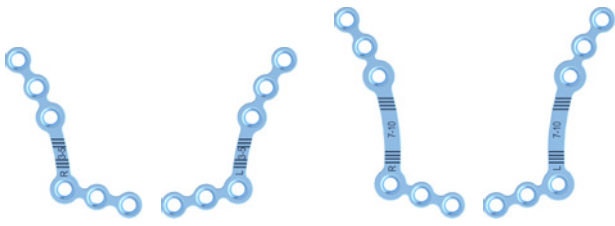
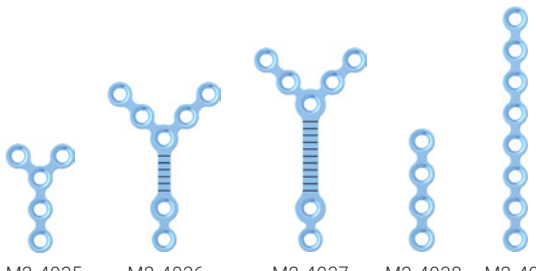

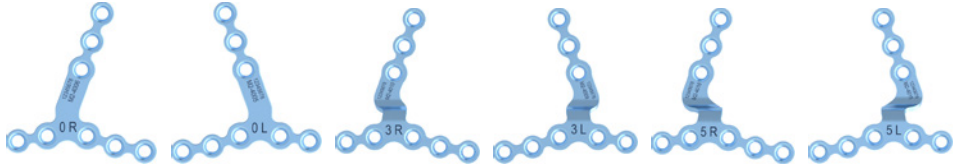







System Overview

The implant plates of MODUS 2 Orthognathics are available in the following designs.

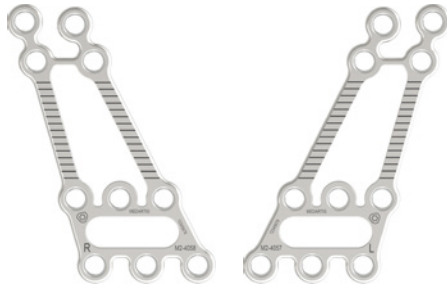
Description	Example	Plate Thickness	
Midface Standard Plates	 <p>M2-4004 M2-4003 M2-4008 M2-4007 M2-4012 M2-4011 M2-4014 M2-4013</p>	0.7 mm	
	 <p>M2-4018 M2-4017 M2-4022 M2-4021 M2-4026 M2-4025</p>		
	 <p>M2-4030 M2-4029 M2-4034 M2-4033</p>		
	 <p>M2-4035 M2-4036 M2-4037 M2-4038 M2-4039</p>		

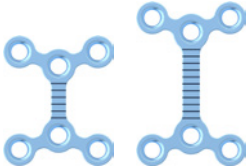
Description	Example	Plate Thickness
Pre-Shaped Midface Plates	 <p>M2-4006 M2-4005 M2-4010 M2-4009 M2-4016 M2-4015</p>	0.7 mm
	 <p>M2-4020 M2-4019 M2-4024 M2-4023 M2-4028 M2-4027</p>	
	 <p>M2-4032 M2-4031 M2-4042 M2-4041</p>	
	 <p>M2-4044 M2-4043 M2-4046 M2-4045</p>	
	 <p>M2-4060 M2-4059 M2-4084 M2-4083</p>	

Description	Example	Plate Thickness
Sagittal Split Plates	 <p>M2-4047 M2-4048</p>	0.7 mm
Sagittal Split Plates	 <p>M2-4049 M2-4050</p>	0.8 mm
Sagittal Split Plate	 <p>M2-4051</p>	0.9 mm
Sagittal Split Plates	 <p>M2-4052 M2-4061 M2-4062</p>	1.0 mm
	 <p>M2-4063 M2-4064 M2-4065</p>	
	 <p>M2-4066</p>	
TriLock Ramus Plates	 <p>M2-4054 M2-4053 M2-4056 M2-4055</p>	1.3 mm
	 <p>M2-4058 M2-4057</p>	

Description	Example	Plate Thickness
Chin Plates	 <p>M2-4070 M2-4072</p>	1.0 mm
Chin Plates, Pre-Shaped (Rigid)	 <p>M2-4074 M2-4076 M2-4078 M2-4080 M2-4082</p>	0.6 mm
Mandible Standard Plates	 <p>M2-4068 M2-4069</p>	1.0 mm
	 <p>M2-4067</p>	

Treatment Concept

The following is an overview of typical clinical findings that can be treated with the implants of MODUS 2 Orthognathics.

LeFort I Osteotomies

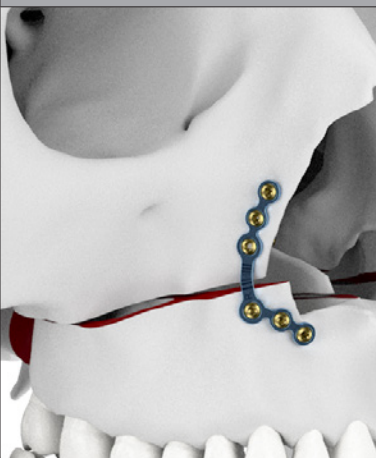
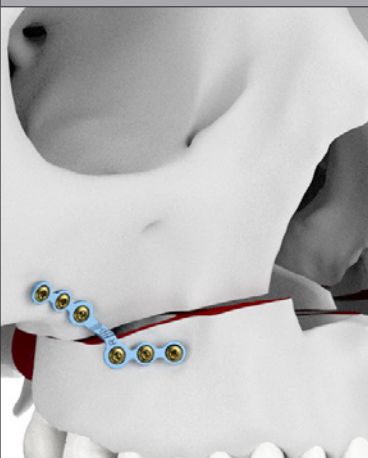
Description	L Plates		Z Plates
Midface Plates, 0.7 mm, Semi-Rigid			
	M2-4003 M2-4004 M2-4007 M2-4008 M2-4011 M2-4012	M2-4013 M2-4014 M2-4017 M2-4018 M2-4021 M2-4022	M2-4025 M2-4026 M2-4029 M2-4030 M2-4033 M2-4034

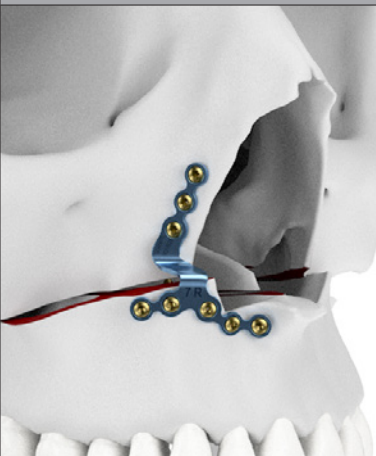
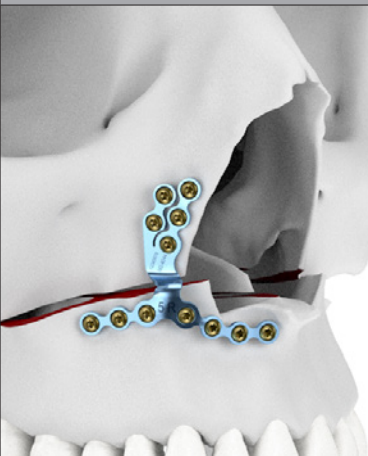
Description	Single Arm, Pre-Shaped Maxillary Plates		Two Arm, Pre-Shaped Maxillary Plates	
Midface Plates, 0.7 mm, Semi-Rigid				
	M2-4005 M2-4006 M2-4009 M2-4010 M2-4015 M2-4016	M2-4019 M2-4020 M2-4023 M2-4024 M2-4027 M2-4028	M2-4031 M2-4032 M2-4041 M2-4042 M2-4043 M2-4044	M2-4045 M2-4046 M2-4059 M2-4060 M2-4083 M2-4084

The above-mentioned information is a recommendation only. The operating surgeon is solely responsible for choosing the appropriate implant for the specific case.

LeFort II Osteotomies

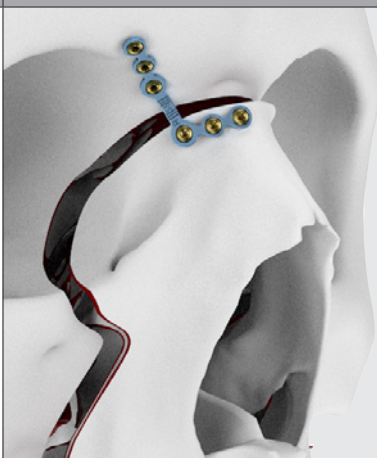
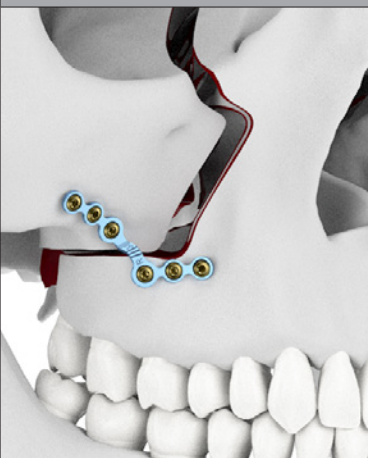
Description	L Plates	Z Plates
Midface Plates, 0.7 mm, Semi-Rigid		
	M2-4003 M2-4004 M2-4007 M2-4008 M2-4011 M2-4012	M2-4013 M2-4014 M2-4017 M2-4018 M2-4021 M2-4022

LeFort III Osteotomies

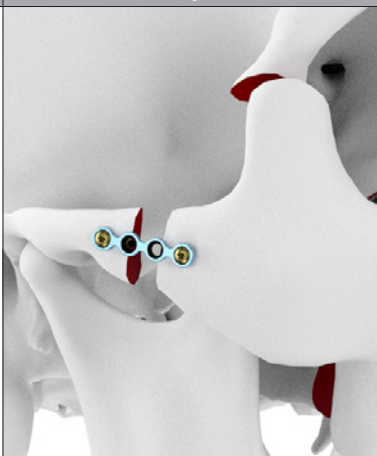
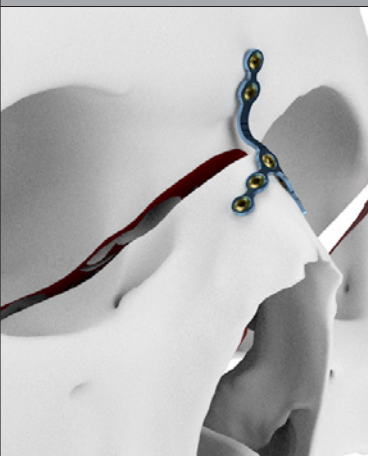
Description	Midface Plates, Straight	Y Plates
Midface Plates, 0.7 mm, Semi-Rigid		
	M2-4038 M2-4039	M2-4035 M2-4036 M2-4037

The above-mentioned information is a recommendation only. The operating surgeon is solely responsible for choosing the appropriate implant for the specific case.

Ramus Osteotomies

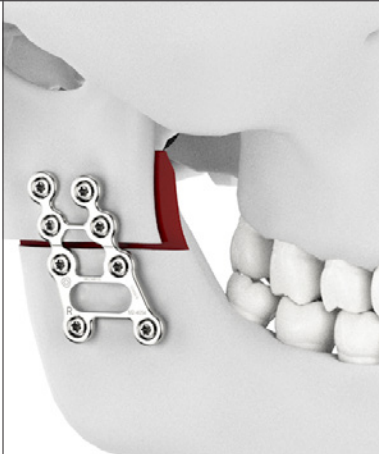
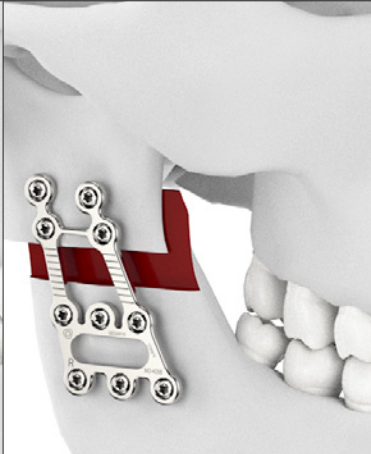

Description	TriLock Ramus Plates	TriLock Ramus Plates
TriLock Ramus Plates, 1.3 mm, Semi-Rigid		
	M2-4053 M2-4054	M2-4055 M2-4056 M2-4057 M2-4058

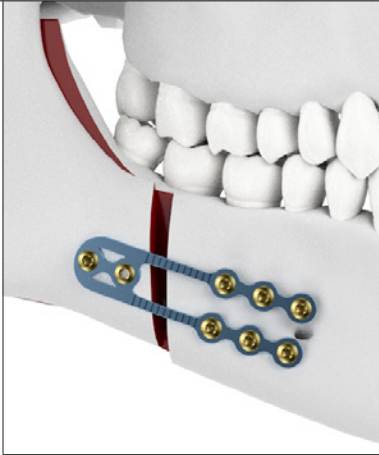
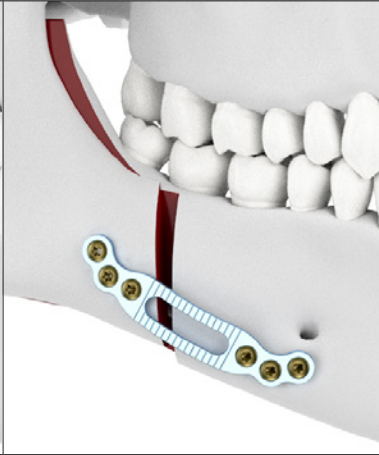
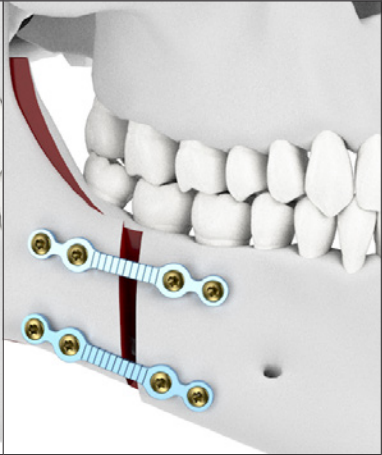
Sagittal Split

Description	Open Sagittal Split Plates	Closed Sagittal Split Plates	Straight Sagittal Split Plates
Sagittal Split Plates, 0.7 mm – 1.0 mm, Semi-Rigid			
	M2-4047 M2-4048 M2-4049	M2-4050 M2-4051 M2-4052	M2-4061 M2-4062 M2-4063 M2-4064 M2-4065 M2-4066

The above-mentioned information is a recommendation only. The operating surgeon is solely responsible for choosing the appropriate implant for the specific case.

Genioplasty

Description	Chin Plates	Pre-Shaped Chin Plates
<p>Chin Plates (M2-4070/ M2-4072 = 1.0 mm, Semi-Rigid) (M2-4074 to M2-4082 = 0.6 mm, Rigid)</p>		
	<p>M2-4070 M2-4072</p>	<p>M2-4074 M2-4076 M2-4078 M2-4080 M2-4082</p>

The above-mentioned information is a recommendation only. The operating surgeon is solely responsible for choosing the appropriate implant for the specific case.

Instrument Application

General Instrument Application

Picking up the Plates

The use of the angled plate and screw holding forceps (M2-2009 or M2-2019) is recommended to remove the plates.

Hold the plate with the forceps as close as possible to the plate-holding pin and pull out of the holder from above.

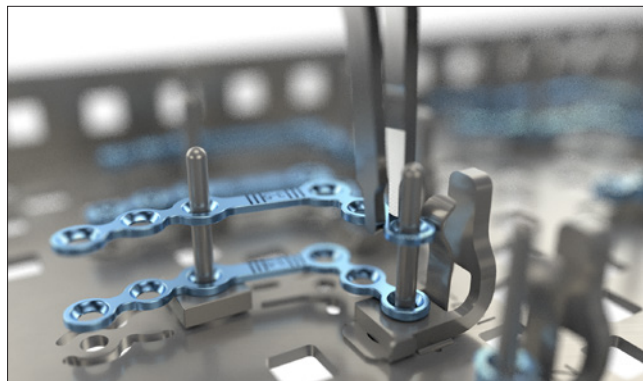

Cutting the Plates

The “cut before bending” principle applies.

There are two different types of cutting pliers which can be used to cut MODUS 2 Orthognathics plates:

Type 1: Plate cutting pliers (M2-2114) to $t \leq 1.3$ mm

Type 2: Plate cutting pliers (A-2046) to $t \leq 1.6$ mm

Warning

Wrong cutting of the plate may result in sharp edges and lead to injuries of the surrounding tissue.

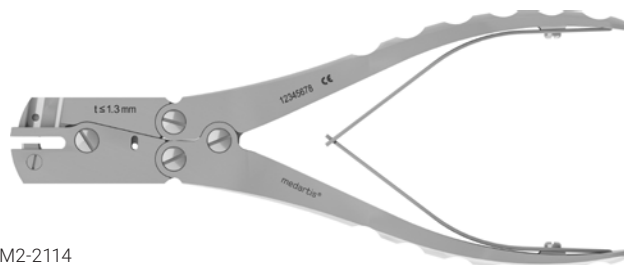

M2-2114
Plate Cutting Pliers $t \leq 1.3$ mm

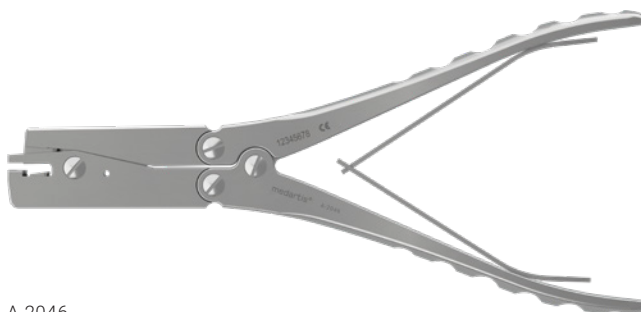

A-2046
1.2–2.8 Plate Cutting Pliers

Type 1

All MODUS 2 Orthognathics plates can be cut with the M2-2114 cutting pliers.

Ensure that there are no remaining plate segments in the cutting pliers (visual check).

Insert the plate from the left into the open cutting pliers. The hole countersinks must face upward.

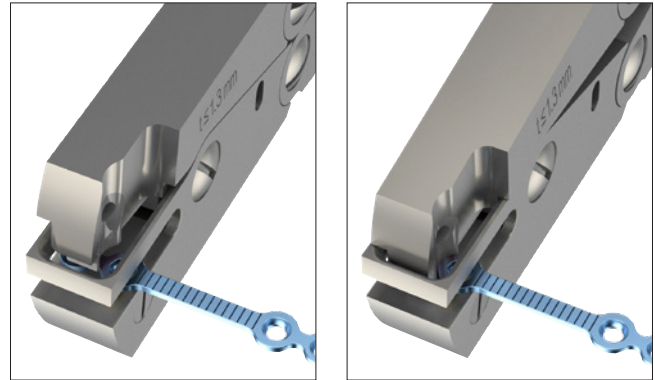
**Notice**

To facilitate the insertion of the plate, support the cutting pliers gently with your middle finger.

You can visually check the desired cutting line through the cutting window in the head of the pliers. Always leave enough material on the rest of the plate to keep the adjacent hole intact. The cutting process rounds off the cut edge. The visible part of the plate corresponds to the desired plate length.



Type 2

All MODUS 2 Orthognathics plates can be cut with the cutting pliers A-2046. Ensure that there are no remaining plate segments in the cutting pliers (visual check). Insert the plate from the front into the open cutting pliers. The hole countersinks must face upward.

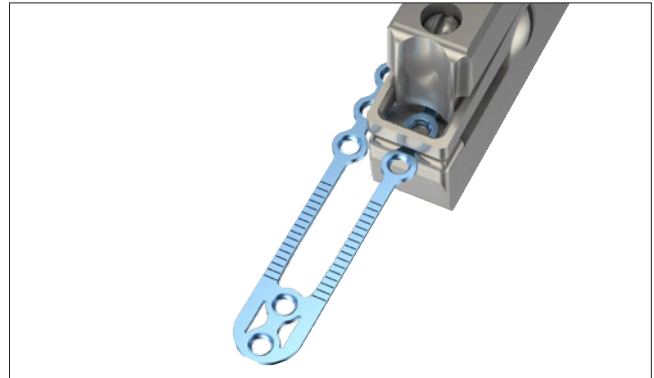

You can visually check the desired cutting line through the cutting window in the head of the pliers. Always leave enough material on the rest of the plate to keep the adjacent hole intact. The cutting process rounds off the cut edge. The visible part of the plate corresponds to the desired plate length.

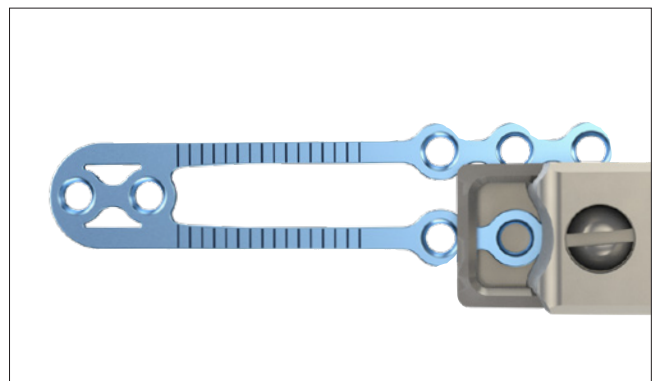

Caution

When cutting with both types of pliers, keep your hand loosely around the pliers to ensure that no parts fly off.

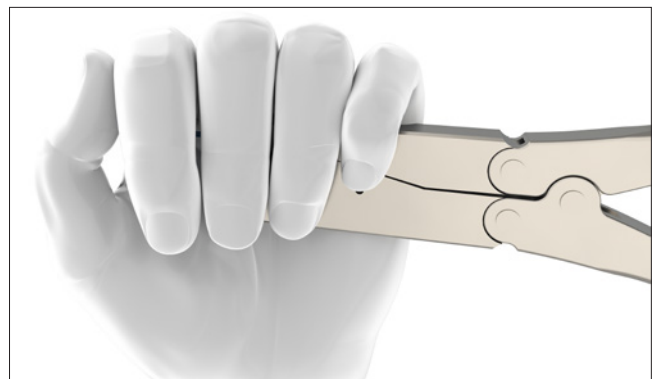

Bending the Plates

If necessary, the MODUS 2 Orthognathics plates can be bent. There are various options available for this.

Warning

Wrong bending of the plate may lead to impaired functionality and postoperative construct failure.

Instrument	Functions
1.2 – 1.8 Plate bending pliers (M2-2002)	Flat plier function Bending outside the plane Bending within the plane
1.2 – 1.8 Plate bending pliers with pin (M2-2012)	Simultaneous bending in multiple planes – 3D
2.0 – 2.3 Plate bending pliers (M2-2006)	Flat plier function Bending outside the plane Bending within the plane
2.0 – 2.3 Plate bending pliers with pin (M2-2158)	Simultaneous bending in multiple planes – 3D

The plate bending pliers with pin are always used in pairs.

To ensure that the TriLock plates lock, they may only be bent with the plate bending pliers with pin (M2-2012, M2-2158).

Flat pliers (for all non-locking plates)

- 1.2 – 1.8 Plate bending pliers (M2-2002)
- 2.0 – 2.5 Plate bending pliers (M2-2006)

The front most part of the jaws of the plate bending pliers can be used as flat nose pliers with a holding function.



M2-2002
1.2-1.8 Plate Bending Pliers



M2-2012
1.2-1.8 Plate Bending Pliers with Pin

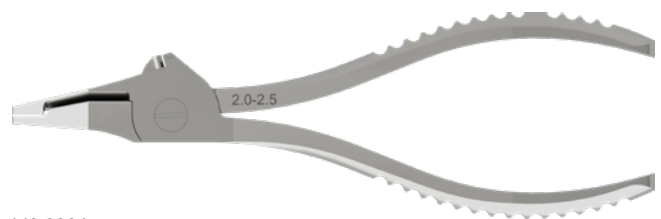

M2-2006
2.0-2.5 Plate Bending Pliers

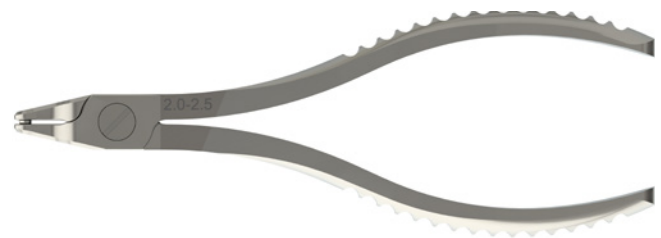

M2-2158
2.0-2.5 Plate Bending Pliers with Pin

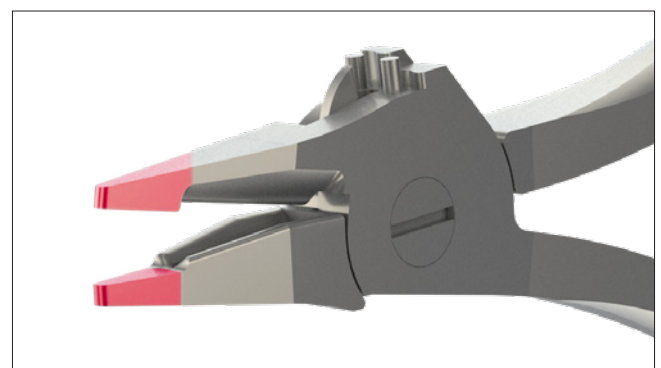

Bending outside the plane (for all non-locking plates)

- 1.2 – 1.8 Plate bending pliers (M2-2002)
- 2.0 – 2.5 Plate bending pliers (M2-2006)

Bars can be bent with the 90° bending function between the jaws of the plate bending pliers.

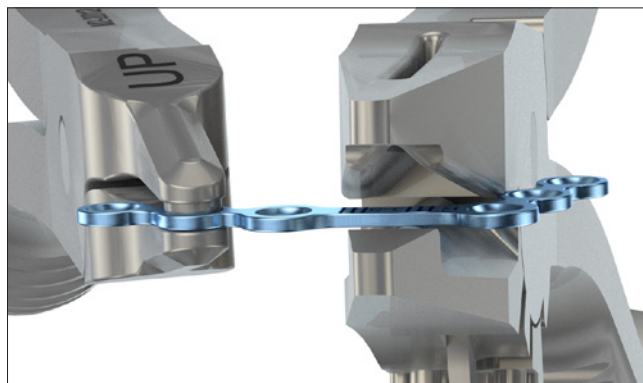

Position the plate in the pliers between the jaws (see image). The slot permits the plate to be viewed. The laser markings on the plate can thereby determine the exact location in which it is bent.

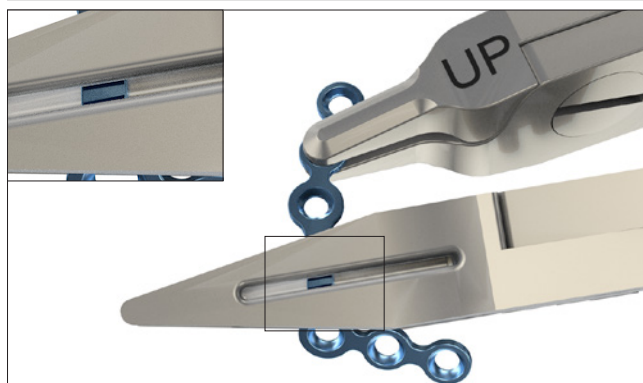
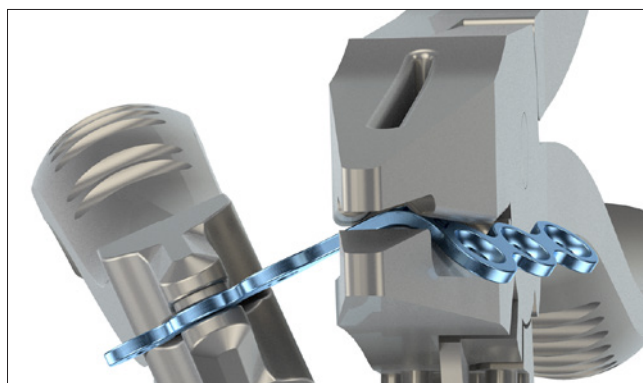

Bending within the plane/Aderer function (for all non-locking plates)

- 1.2 – 1.8 Plate bending pliers (M2-2002)
- 2.0 – 2.5 Plate bending pliers (M2-2006)

A three-jaw plier function known as the "Aderer function" is integrated into the plate bending pliers for non-locking plates so that the plates bend in the plane.

Place the plate onto the pins. Closing the pliers will bend the plate within the plane.

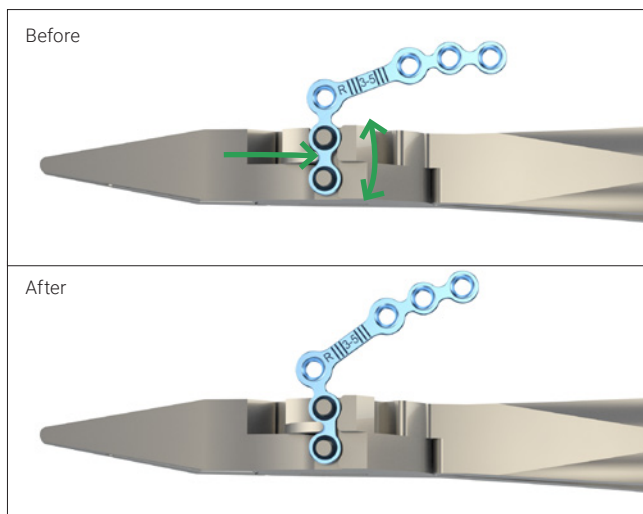

Simultaneous bending in multiple planes/3D bending (for all plates)

1.2 – 1.8 Plate bending pliers (M2-2012)

2.0 – 2.5 Plate bending pliers (M2-2158)

Hold the pliers so that the pin enters the plate hole from above (with the “UP” marking on the plate bending pliers pointing upward). The purpose of this process is to protect the plate hole from deformities.

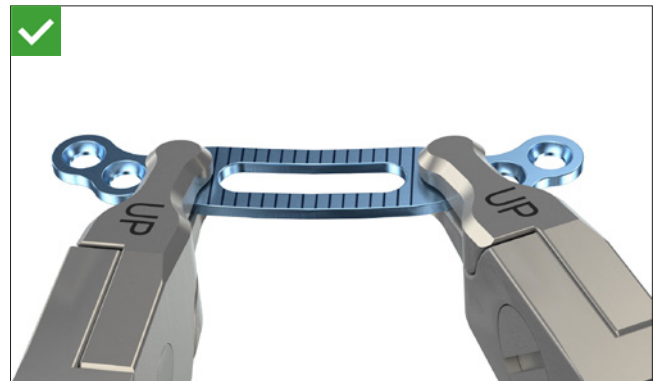

While bending, the plate must always be held at two adjacent holes to prevent contour deformation of the intermediate plate hole.

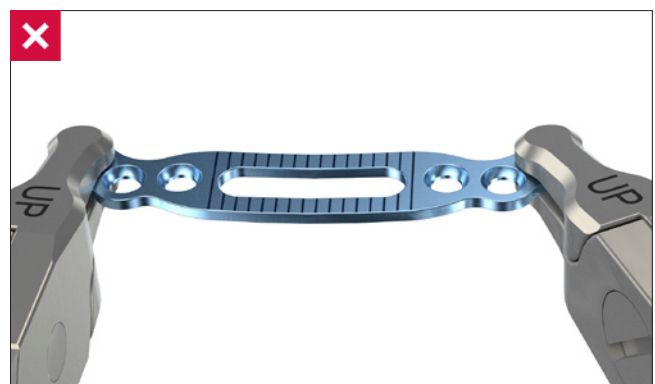

Regularly check the curvature of the plate to prevent overbending and thereby excess strain on the plate.

Warning

Repeatedly bending the plate in opposite directions may cause the plate to break postoperatively. Always use the provided plate bending pliers to avoid damaging the plate holes. Damaged plate holes prevent correct and secure seating of the screw in the plate and increase the risk of system failure.

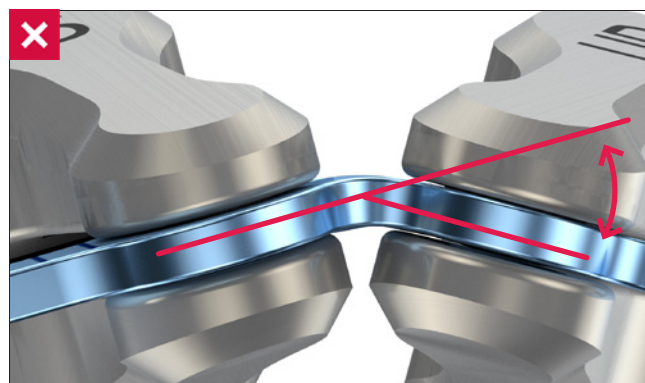

Warning

Do not bend plates without a bar by more than 30°. Bending the plate further may deform the plate holes and may cause the plate to break postoperatively.

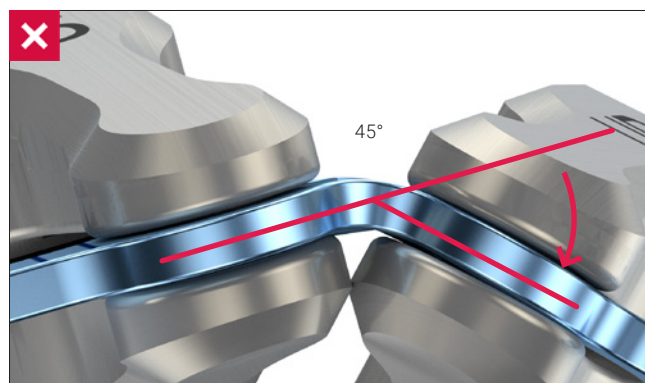
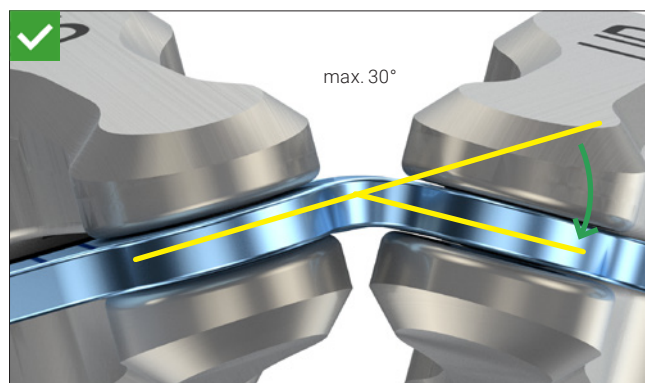

Drills

Color-coded twist drills are available for each MODUS 2 screw diameter. All drills are color coded with a ring system.

Screw Diameter	Color Code
1.2	Red
1.5	Green
1.8	Yellow
2.0	Blue
2.3	Brown

There are two different types of twist drill: Core hole drills are marked with one colored ring and gliding hole drills (for lag screw technique) are marked with two colored rings.

Core Hole Drills (one colored ring)

Drills for screws Ø 1.2 (drill Ø 1.0)

Dental	Stryker	
M2-3012	M2-3022	5 mm
M2-3032	M2-3042	7 mm
M2-3052	M2-3062	25 mm



Drills for screws Ø 1.5 (drill Ø 1.2)

Dental	Stryker	
M2-3122	M2-3132	5 mm
M2-3142	M2-3152	7 mm
M2-3162	M2-3172	25 mm



Drills for screws Ø 1.8 (drill Ø 1.5)

Dental	Stryker	
M2-3212	M2-3222	5 mm
M2-3232	M2-3242	7 mm
M2-3252	M2-3262	25 mm

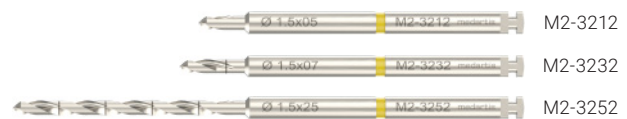

Drills for screws Ø 2.0 (drill Ø 1.5)

Dental	Stryker	
M2-3119	M2-3129	5 mm
M2-3139	M2-3149	7 mm
M2-3159	M2-3169	25 mm



Drills for screws Ø 2.3 (drill Ø 1.9)

Dental	Stryker	
M2-3176	M2-3186	7 mm
M2-3196	M2-3206	25 mm



Gliding Hole Drills (two colored rings)

Drills for screws Ø 1.2 (drill Ø 1.2)

Dental	Stryker	
M2-3072	M2-3082	25 mm



Drills for screws Ø 1.5 (drill Ø 1.5)

Dental	Stryker	
M2-3182	M2-3192	25 mm



Drills for screws Ø 1.8 (drill Ø 1.8)

Dental	Stryker	
M2-3272	M2-3282	25 mm



Drills for screws Ø 2.0 (drill Ø 2.0)

Dental	Stryker	
M2-3156	M2-3166	25 mm



Drills for screws Ø 2.3 (drill Ø 2.3)

Dental	Stryker	
M2-3336	M2-3346	25 mm



Drilling with Drill Guide

Drilling with a drill guide protects surrounding tissue from direct contact with the drill.

After positioning the plate, insert the drill guide and the twist drill into the screw hole. The drill is guided by the shaft of the drill and not the drill flute.



Drilling with 1.2–1.8 drill guide (M2-2002)

The 1.2–1.8 drill guide (M2-2202) can be used for MODUS 2 Orthognathics Midface plates.

The end of the drill guide marked with 1.0/1.5 is used with drills with a maximum diameter of 1.2 mm. The opposite end is designed for use with twist drills from a diameter of 1.5 mm.

Notice

To drill a gliding hole for the screw diameter 1.5 mm, use the end of the drill guide marked with 1.8.

Drilling with 2.0–2.5 drill guide (M2-2198)

The 2.0–2.5 drill guide (M2-2198) can be used for MODUS 2 Orthognathics Mandible TriLock plates and fixation plates.

Drills for use with the drill guides:

Core Hole Drills (one colored ring)

Drills for screws Ø 1.2 (drill Ø 1.0)

Dental	Stryker	
M2-3382	M2-3392	25 mm



Drills for screws Ø 1.5 (drill Ø 1.2)

Dental	Stryker	
M2-3402	M2-3412	25 mm



Drills for screws Ø 1.8 (drill Ø 1.5)

Dental	Stryker	
M2-3422	M2-3452	25 mm



Drills for screws Ø 2.0 (drill Ø 1.5)

Dental	Stryker	
M2-3459	M2-3469	25 mm



Drills for screws Ø 2.3 (drill Ø 1.9)

Dental	Stryker	
M2-3216	M2-3226	25 mm



Gliding Hole Drills (two colored rings)

Drills for screws Ø 1.2 (drill Ø 1.2)

Dental	Stryker	
M2-3322	M2-3332	25 mm



Drills for screws Ø 1.5 (drill Ø 1.5)

Dental	Stryker	
M2-3342	M2-3352	25 mm



Drills for screws Ø 1.8 (drill Ø 1.8)

Dental	Stryker	
M2-3362	M2-3372	25 mm



Drills for screws Ø 2.0 (drill Ø 2.0)

Dental	Stryker	
M2-3296	M2-3306	25 mm



Drills for screws Ø 2.3 (drill Ø 2.3)

Dental	Stryker	
M2-3316	M2-3326	25 mm



Warning

For locking plates ensure that the screw holes are predrilled with a pivoting angle of no more than $\pm 15^\circ$. For this purpose, the drill guides show a limit stop at $\pm 15^\circ$. A predrilled pivoting angle of $> 15^\circ$ no longer allows the TriLock screws to correctly lock in the plate.

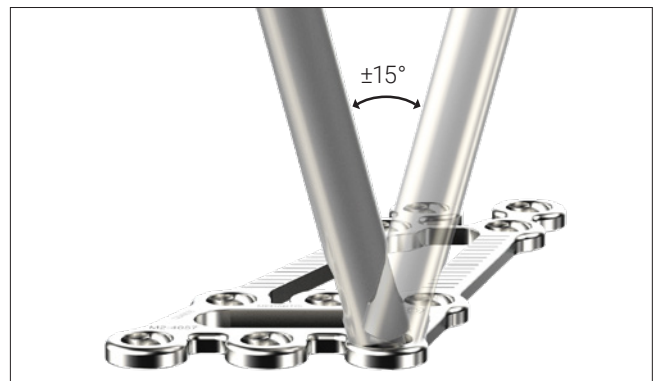

Assigning the Screw Length

The depth gauge (M2-2250) is used to determine the ideal screw length for use in monocortical or bicortical screw fixation.

Retract the slider of the depth gauge.



M2-2250
1.2–2.3 Depth Gauge



The caliper of the depth gauge has a hooked tip that is either inserted to the bottom of the hole or is used to catch the far cortex of the bone. When using the depth gauge, the caliper stays static and only the slider is adjusted.



To assign the screw length, place the distal end of the slider onto the implant plate.



The ideal screw length for the assigned drill hole can be read on the scale of the depth gauge.

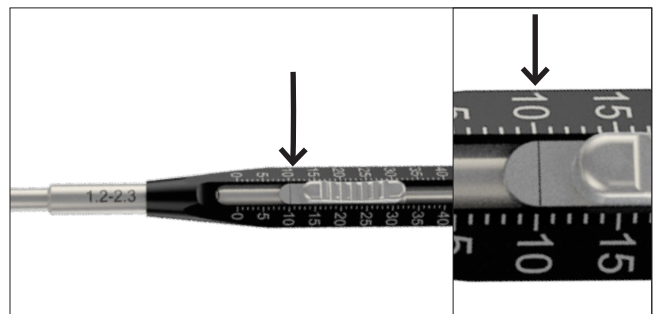

Screw Pick-Up

The screwdriver handles M2-2001, M2-2003 and M2-2040 are compatible with the screwdriver blades M2-2004 and M2-2005. Both screwdriver blades feature the patented self-holding technology HexaDrive.



M2-2001
Type 2 Screwdriver Handle



M2-2003
Type 1 Screwdriver Handle



M2-2040
Type 3 Screwdriver Handle



M2-2004
Screwdriver Blade, HD4, 80 mm



M2-2005
Screwdriver Blade, HD6, 95 mm

Notice

All screws up to 7 mm in length are secured with a securing element. To remove these screws, turn the securing element to the right with the screwdriver. This releases the screws.

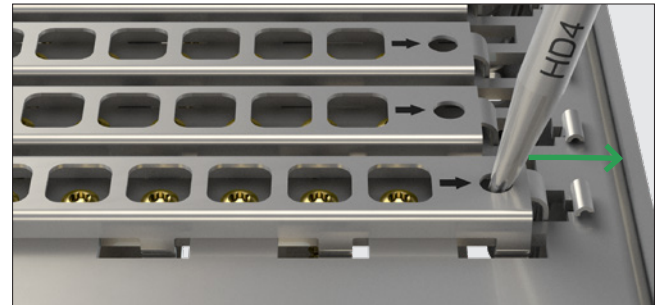

To remove the screws from the implant container, insert the appropriately color-coded screwdriver blade perpendicularly into the screw head of the desired screw and pick up the screw with axial pressure.

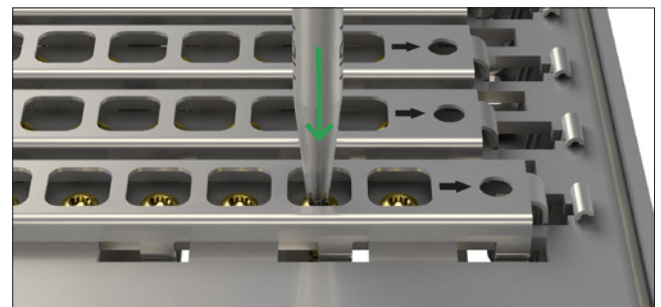

Notice

The screw will not hold without axial pressure.

Caution

Vertically extract the screw from the compartment. Picking up the screw repeatedly may lead to permanent deformation of the self-retaining area of the HexaDrive inside the screw head. Therefore, the screw may no longer be able to be picked up correctly. In this case, a new screw has to be used.

Notice

The screw length is checked with the measuring module and read at the end of the screw head.

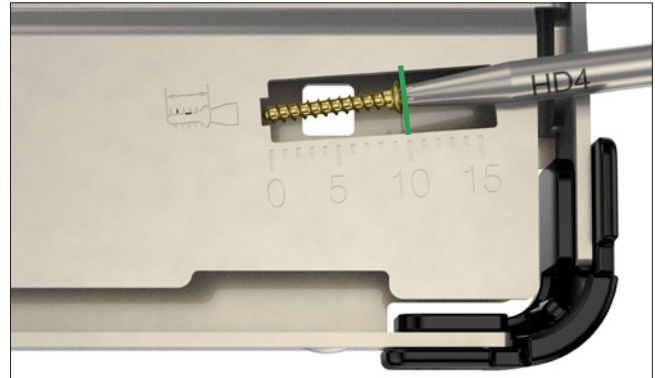

Check the correct screw diameter: The screw can be inserted into the hole of the appropriate screw diameter. The screw will not fit in the hole for the next screw size down.

Notice

Check SpeedTip screws in the hole \varnothing 1.8 or \varnothing 2.3.

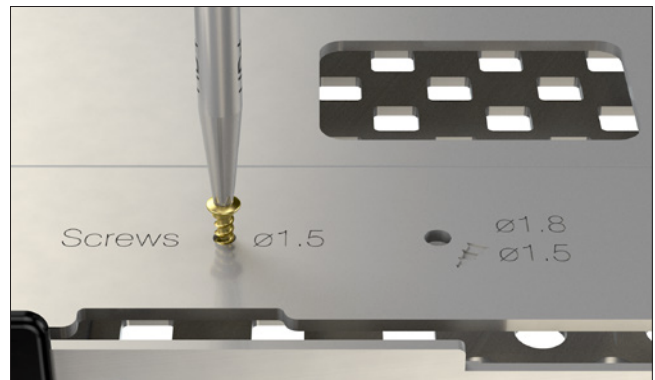
**Notice**

After removing screws up to a length of 7 mm it is important to ensure that the securing elements are closed again to prevent the screws from dropping out. To do this, lightly press down on the outer left of the securing element and it will close of its own accord.

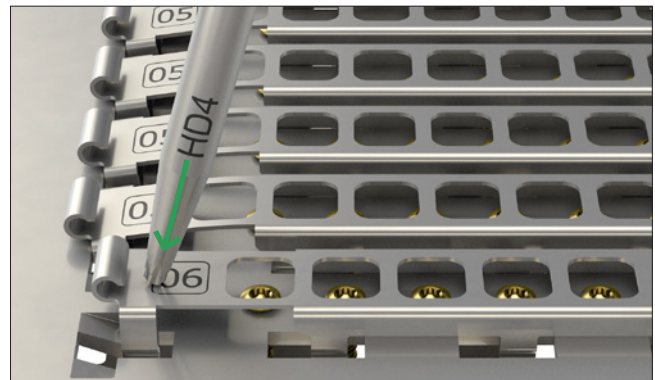

Screws secured with a securing element cannot be directly removed with the 90° screwdriver.

These screws must be removed with the screwdriver blade and stored temporarily in the screw measuring module. From here the screw can be picked up with the 90° screwdriver.



Surgical Techniques

General Surgical Techniques

Lag Screw Technique

Warning

Incorrect application of the lag screw technique may result in postoperative loss of reduction.

1. Drilling the core hole

Use the core hole drill (one colored ring) of the same screw diameter to drill to the far cortex.

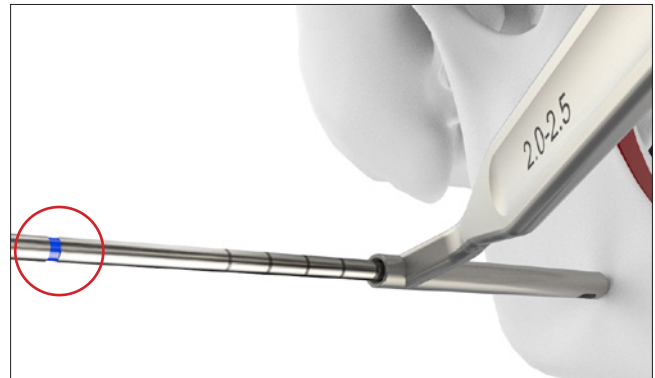

2. Drilling the gliding hole

Use the gliding hole drill (two colored rings) of the corresponding screw diameter to drill up to the osteotomy line.

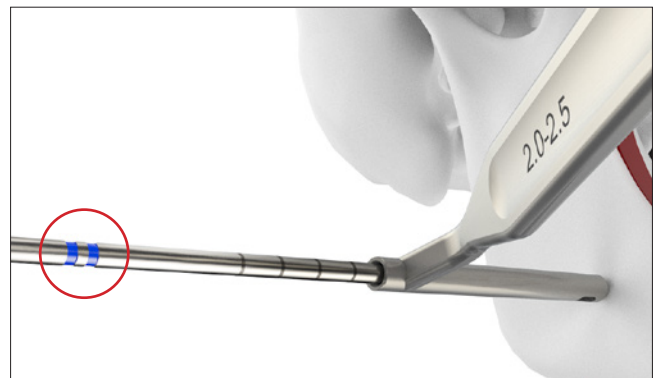

3. Compressing

Compress with the corresponding cortical screw.

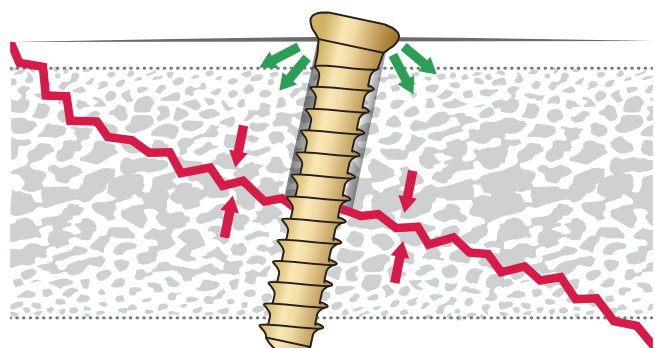

Specific Surgical Techniques

Fixation of a LeFort I Osteotomy

The following plates can be selected for osteosynthesis for a LeFort I osteotomy: A left plate and a right plate are available for each plate size.

L	R	
M2-4003, M2-4004		Medial L plates for forward displacements up to a max. 3 mm and backward displacements
M2-4007, M2-4008		Medial L plates for forward displacements up to a max. 5 mm M2-4011, M2-4012
M2-4013, M2-4014		Medial L plates for forward displacements up to a max. 7 mm M2-4017, M2-4018
M2-4021, M2-4022		Medial L plates for forward displacements up to a max. 10 mm
L	R	
M2-4025, M2-4026		Lateral Z plates for backward displacements
M2-4029, M2-4030		Lateral Z plates for forward displacements up to a max. 5 mm
M2-4033, M2-4034		Lateral Z plates for forward displacements up to a max. 10 mm

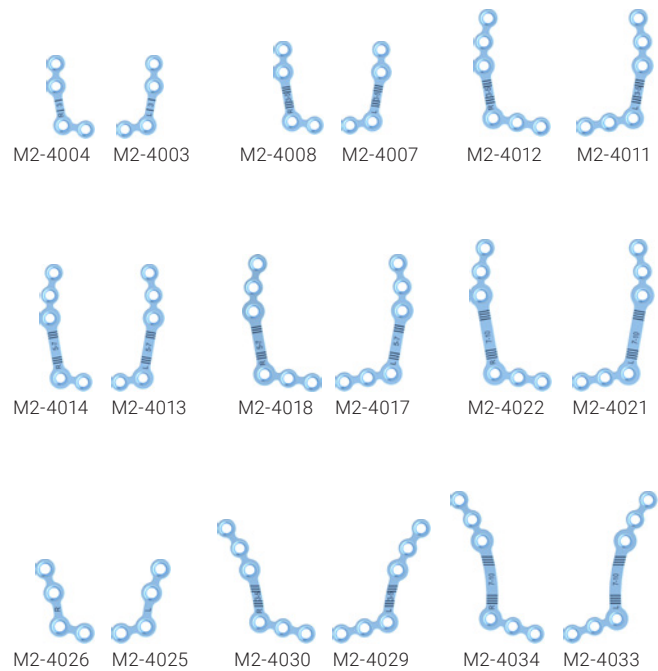

Selecting the plate

After performing the LeFort I osteotomy, set the occlusion and perform temporary IMF. Select the suitable plate based on the displacement width.

The laser markings serve as guides for bending by providing an indication of the size of the potential offset.

Procedure

First perform the osteosynthesis medially and then laterally. L plates are especially well suited for osteosynthesis in the medial region.

Z plates are especially well suited for osteosynthesis in the lateral region.

L	R	
M2-4005, M2-4006		Medial pre-shaped maxillary plates for forward displacements of 0 mm
M2-4009, M2-4010		Medial pre-shaped maxillary plates for forward displacements of 3 mm
M2-4015, M2-4016		Medial pre-shaped maxillary plates for forward displacements of 5 mm
M2-4019, M2-4020		Medial pre-shaped maxillary plates for forward displacements of 7 mm
M2-4023, M2-4024		Medial pre-shaped maxillary plates for forward displacements of 9 mm
M2-4027, M2-4028		Medial pre-shaped maxillary plates for forward displacements of 11 mm

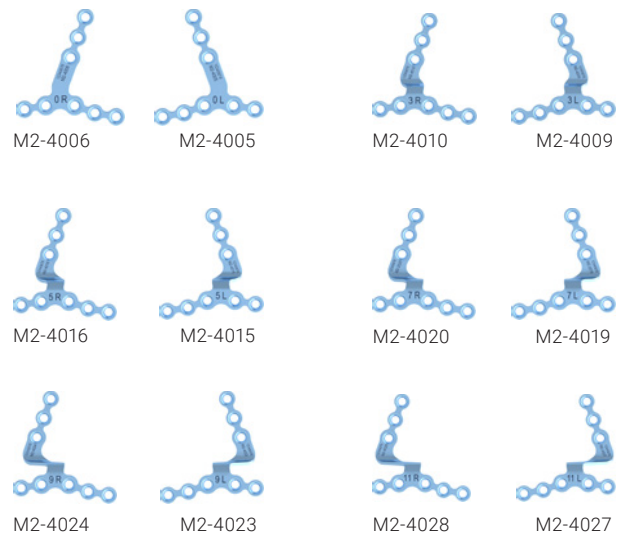

L	R	
M2-4031, M2-4032		Medial pre-shaped maxillary plates for forward displacements of 0 mm
M2-4041, M2-4042		Medial pre-shaped maxillary plates for forward displacements of 3 mm
M2-4043, M2-4044		Medial pre-shaped maxillary plates for forward displacements of 5 mm
M2-4045, M2-4046		Medial pre-shaped maxillary plates for forward displacements of 7 mm
M2-4059, M2-4060		Medial pre-shaped maxillary plates for forward displacements of 9 mm
M2-4083, M2-4084		Medial pre-shaped maxillary plates for forward displacements of 11 mm

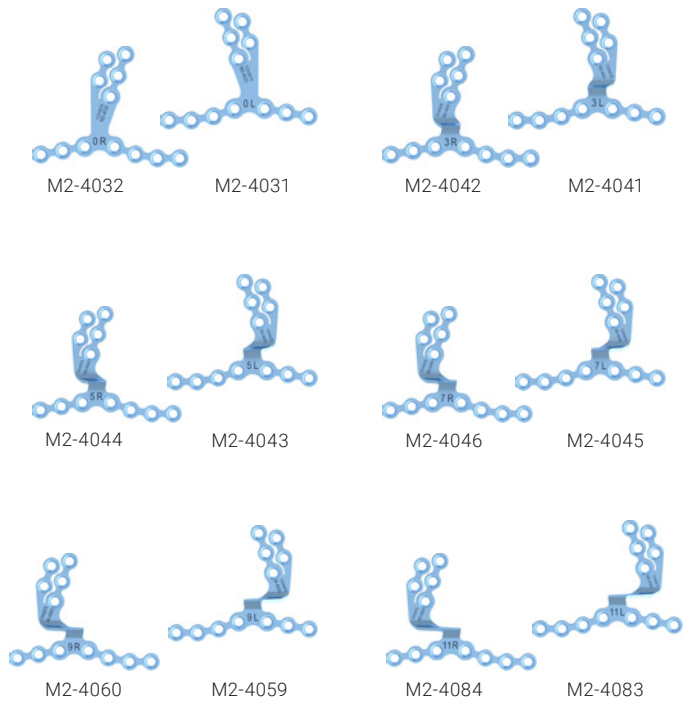

Selecting the plate

After performing the LeFort I osteotomy, set the occlusion and perform temporary IMF. Select the suitable plate based on the displacement width.

Procedure

Pre-shaped maxillary plates are intended for osteosynthesis in the medial region.



1. Cutting the plate

If required, the plate can be cut with plate cutting pliers (M2-2114 or A-2046).

Warning

Leave enough material on the rest of the plate to keep the adjacent hole intact.

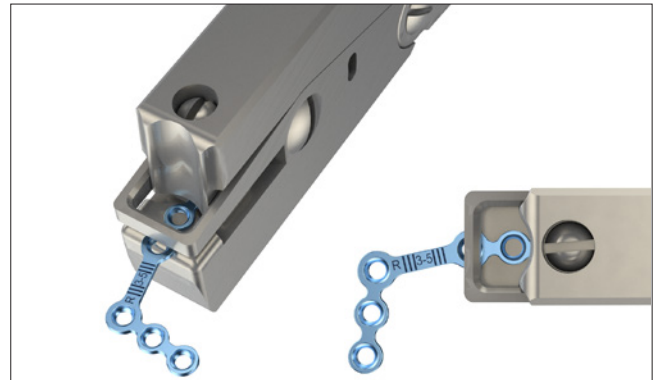

2. Using the instruments

Use the plate bending pliers (M2-2012/M2-2002) to contour the plate to the patient's bone structure (see section "Bending the Plates").

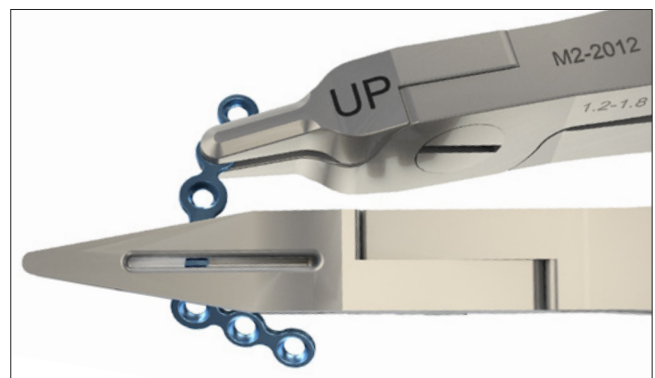
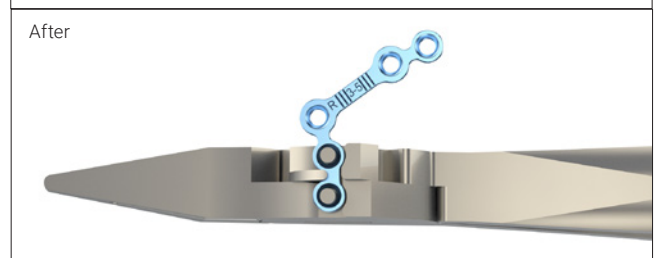
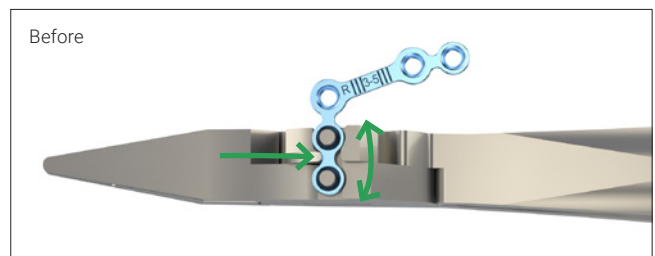

If required, the plate can be positioned more medially or laterally by taking the following steps:

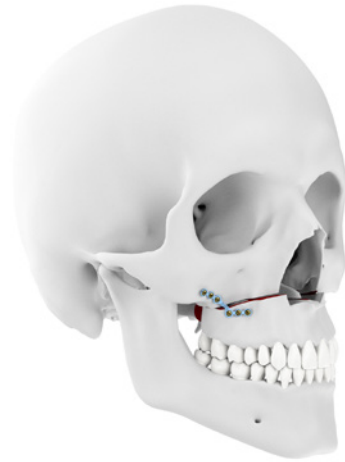

1. Hold the plate with the plate bending pliers (M2-2002/M2-2012).

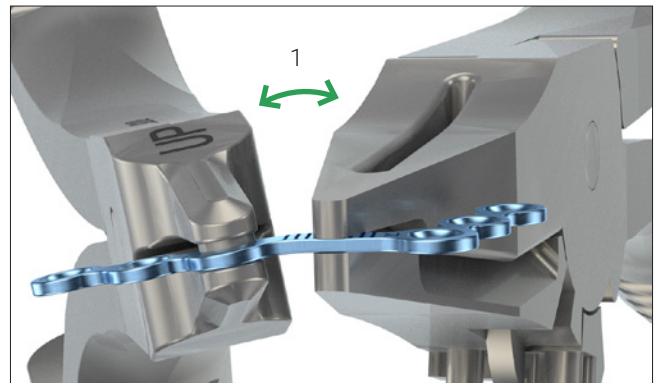

2. Bend the plate arm with the plate bending pliers (M2-2002/M2-2012): medial (see arrow 1), lateral (see arrow 2).

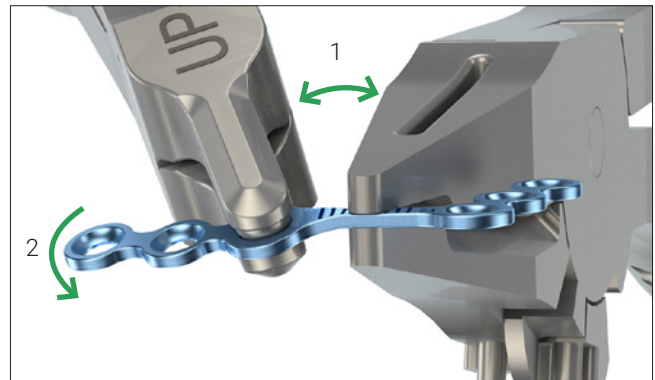

3. Fix the plate with 1.5 SpeedTip screws (with no predrilling) or with 1.2/1.5/1.8 cortical screws (with predrilling).

Warning

A minimum of two cortical screws must be used on each side of the osteotomy.

Repeat steps 1–3 until all four plates are secured.

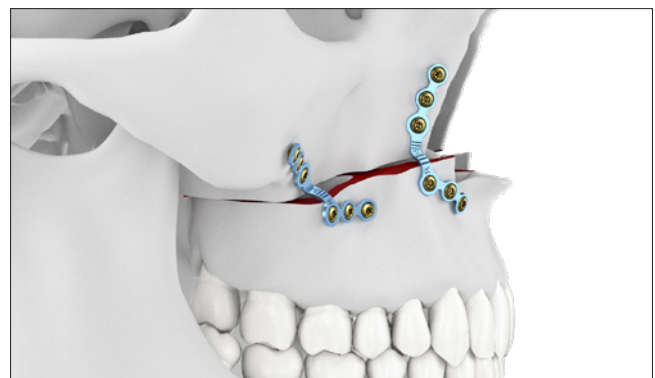

Fixation of a Sagittal Split in the Horizontal Mandibular Ramus with an Open, Flexible Sagittal Split Plate with Slider Option (M2-4047, M2-4048, M2-4049)

The following plates can be selected for the osteosynthesis for sagittal splits:

M2-4047	For forward displacements up to a max. 5 mm and backward displacements
M2-4048	For forward displacements up to a max. 10 mm
M2-4049	For forward displacements up to a max. 15 mm

Sliders

M2-5242.08	2.0 Slider, fenestrated 8 mm, HD6
M2-5252.08	2.3 Slider, fenestrated 8 mm, HD6



M2-4047



M2-4048



M2-4049



M2-5242.08



M2-5252.08

The fixation of the sagittal split with the open, flexible plate design follows the treatment concept of Prof. Ulrich Joos (Münster, Germany).

According to this concept, intermaxillary fixation (IMF) is used for 1–3 days postoperatively, followed by rubber bands.

1. Selecting the plate

After performing the sagittal split, set the occlusion and perform temporary IMF. Select the suitable plate based on the width of the osteotomy split. Fixation close to the osteotomy ensures increased stability in the area of the fracture split.



2. Cutting the plate

The plate can optionally be shortened using the cutting pliers (M2-2114 or A-2046).

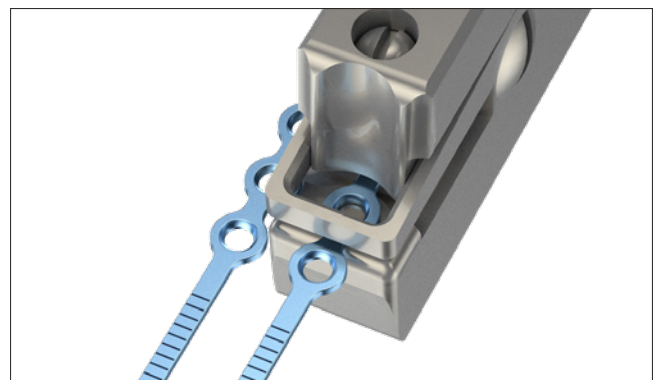

Caution

Do not use the plate bending pliers to contour the plate to the patient's bone structure.



3. Posterior fixation

Position the plate. The nerve must run centrally between the two arms.

Fix the plate with 2.0 SpeedTip screws (with no predrilling) or with 2.0/2.3 cortical screws (with predrilling).

Insert the first screw posteriorly, monocortically and next to the osteotomy split (distance to osteotomy split approx. 3 mm).

Perform only monocortical screw insertion in the posterior segment.

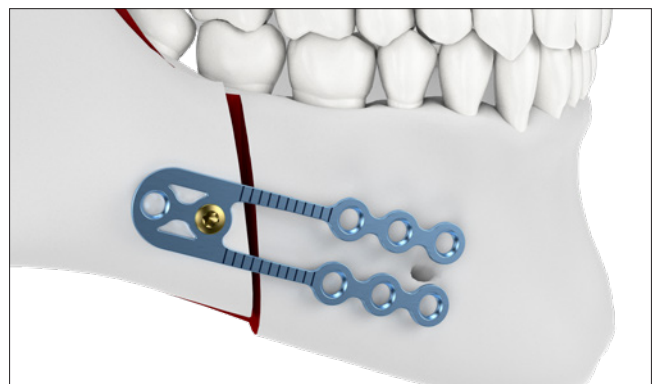

4. Positioning the slider

Position the slider in the anterior segment (centrally) as an intraoperative aid for occlusion adjustment.

5. Repeat steps 3 and 4 on the opposite side of the mandible.

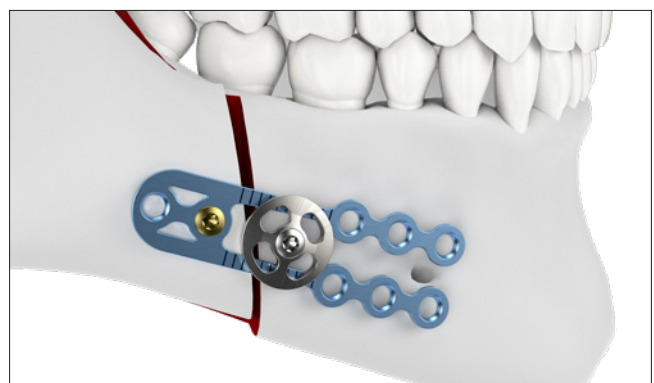

6. Checking the occlusion

Loosen the IMF and check the occlusion. If necessary, make adjustments by loosening the slider and making slight adjustments to the position of the anterior segment. Adjustments can be made in both the vertical and horizontal planes.

Retighten the slider and check dental and jaw positioning until the desired occlusion is achieved.

Repeat the IMF.

Notice

Laser markings help when estimating the width of the osteotomy split.

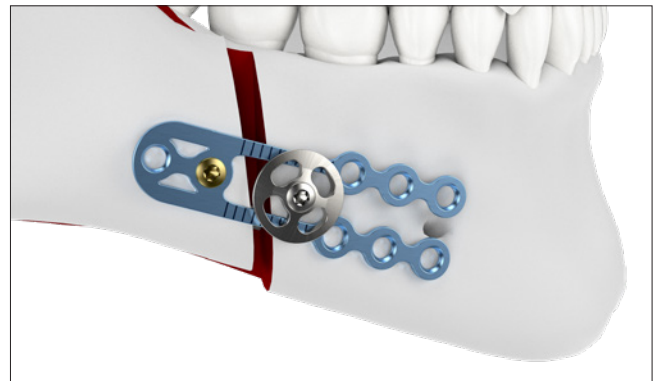

7. Final posterior fixation

Perform final fixation of the first posterior screw and insert the second posterior screw (monocortical).

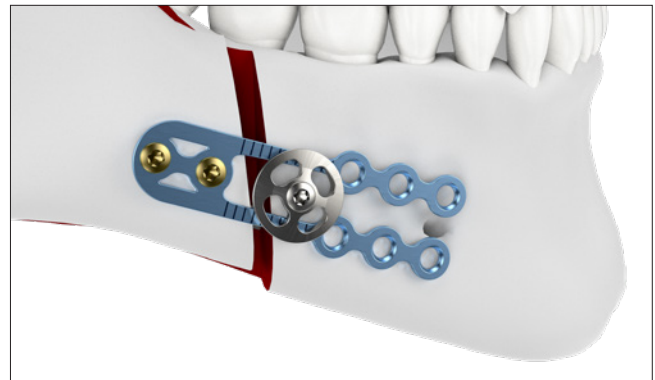

8. Final anterior fixation

Insert screws in the anterior plate holes not covered by the slider.

Warning

A minimum of four cortical screws must be used on the anterior side. It is essential that screws are inserted in the screw holes next to the bar.

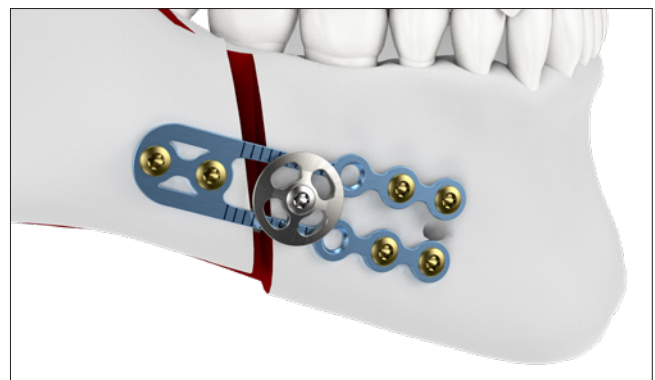

9. Removing the slider

Remove the slider and insert screws in the remaining anterior screw holes.

Caution

The slider is only an intraoperative aid for adjusting the occlusion and must be removed after the osteosynthesis has been completed.

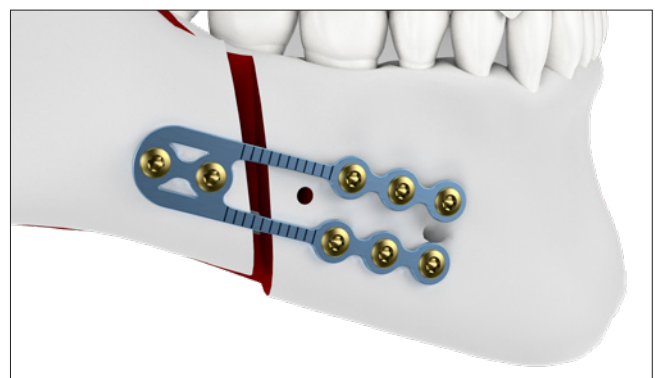

Fixation of a Sagittal Split in the Horizontal Mandibular Ramus with a Closed, Semi-Rigid Sagittal Split Plate with Slider Option (M2-4050, M2-4051, M2-4052)

The following plate designs can be selected for semi-rigid osteosynthesis for sagittal splits:

M2-4050	For forward displacements up to a max. 5 mm and backward displacements (without slider)
---------	---

M2-4051	For forward displacements up to a max. 10 mm
---------	--

M2-4052	For forward displacements up to a max. 15 mm
---------	--

Sliders

M2-5242.08	2.0 Slider, fenestrated 08 mm, HD6
------------	------------------------------------

M2-5252.08	2.3 Slider, fenestrated 08 mm, HD6
------------	------------------------------------



M2-4050



M2-4051



M2-4052



M2-5242.08



M2-5252.08

1. Selecting the plate

After performing the sagittal split, set the occlusion and perform temporary IMF. Select the suitable plate based on the width of the osteotomy split. Fixation close to the osteotomy ensures increased stability in the osteotomy split.



2. Bending the plate

If required, use the plate bending pliers (M2-2158/ M2-2006) to contour the plate to the patient's bone structure (see section "Bending the Plates").

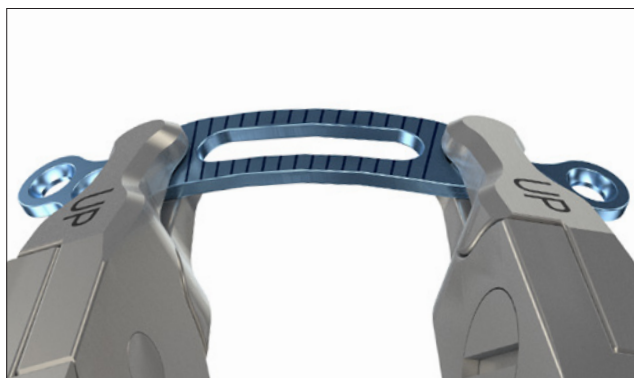

3. Posterior fixation

Position the plate and fix with 2.0 SpeedTip screws (with no predrilling) or with 2.0/2.3 cortical screws (with predrilling).

Insert the first screw posteriorly, monocortically and next to the osteotomy split (distance to osteotomy split approx. 3 mm). Do not yet tighten the screw fully (makes adjustment easier, see step 5).

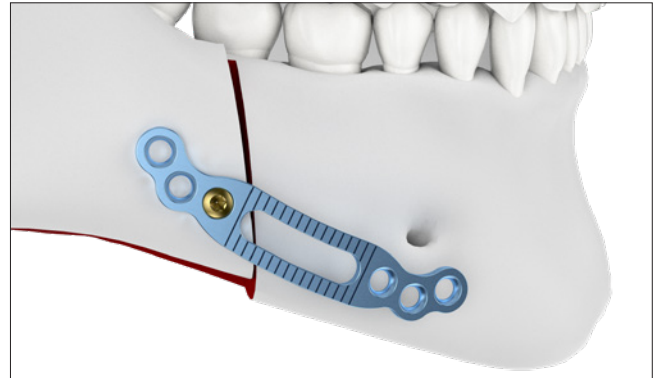

4. Positioning the slider

For plates M2-4051 or M2-4052, the optional use of a slider in the anterior segment can serve as an intraoperative aid to adjust the occlusion.

If working without a slider, the screws can be inserted directly, first in the posterior (monocortical) and then in the anterior region.

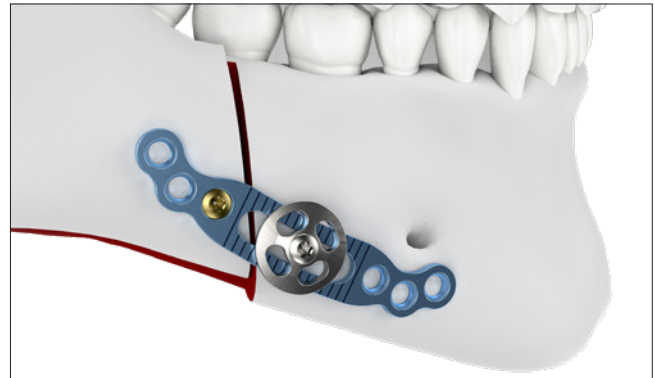

5. Repeat steps 3 and 4 on the opposite side of the mandible.

6. Checking the occlusion

Loosen the IMF and check the occlusion. If necessary, make adjustments by loosening the slider and making slight adjustments to the position of the anterior segment. Adjustments can be made in both the vertical and horizontal planes.

Retighten the slider and check dental and jaw positioning until the desired occlusion is achieved.

Repeat the IMF. Laser markings help when estimating the width of the osteotomy split.

Without the slider: Loosen the screws and adjust the position of the anterior segment.

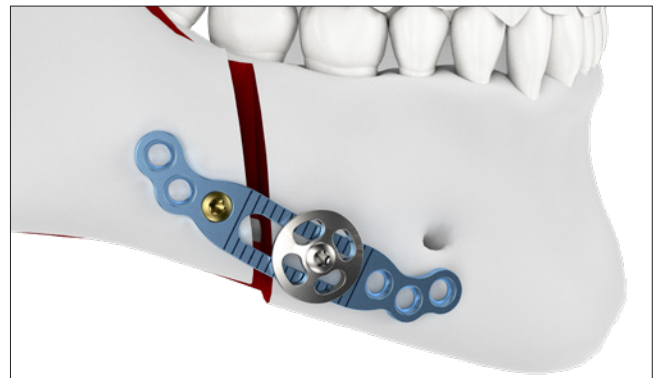

7. Final posterior fixation

Insert the remaining posterior screws (monocortical).

Warning

A minimum of 2 cortical screws must be used on each side of the osteotomy.

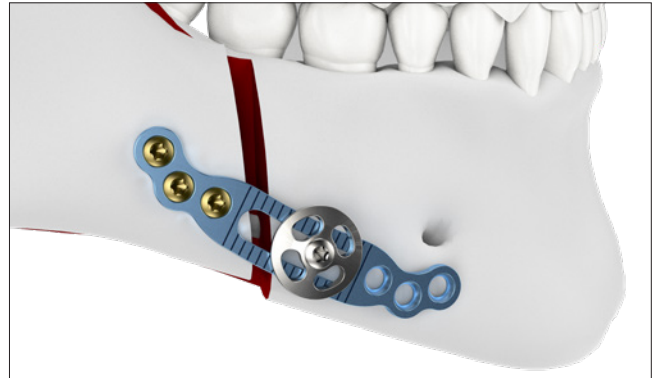

8. Final anterior fixation

Insert screws in the anterior screw holes not covered by the slider.

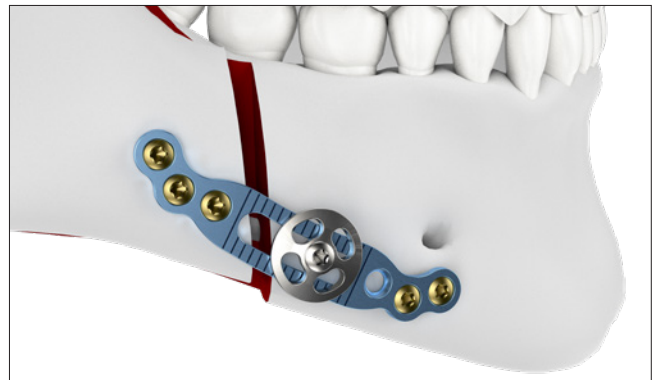

9. Removing the slider

Remove the slider and insert screws in the remaining anterior screw holes.

Caution

The slider is only an intraoperative aid for adjusting the occlusion and must be removed after the osteosynthesis has been completed.

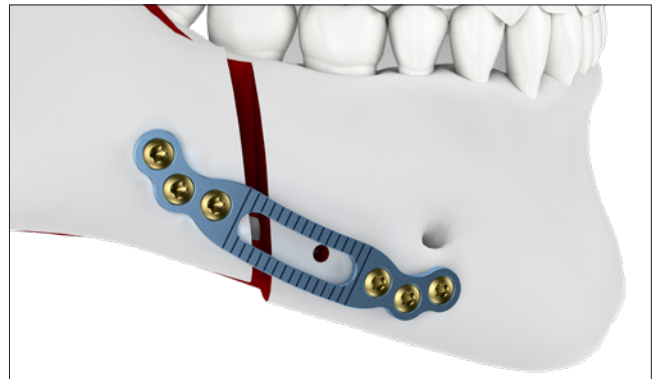

Fixation after a Horizontal Ramus Osteotomy with the TriLock Ramus Plate with Slider Option (M2-4053, M2-4054, M2-4055, M2-4056, M2-4057, M2-4058)

The following plate designs can be selected for osteosynthesis following osteotomies on the ascending ramus:

M2-4053	Purely horizontal forward or backward displacement (left side of the patient)
M2-4054	Purely horizontal forward or backward displacement (right side of the patient)
M2-4055	Vertical displacements of max. 7 mm (left side of the patient) and horizontal forward or backward displacement
M2-4056	Vertical displacements of max. 7 mm (right side of the patient) and horizontal forward or backward displacement
M2-4057	Vertical displacements of max. 14 mm (left side of the patient) and horizontal forward or backward displacement
M2-4058	Vertical displacements of max. 14 mm (right side of the patient) and horizontal forward or backward displacement

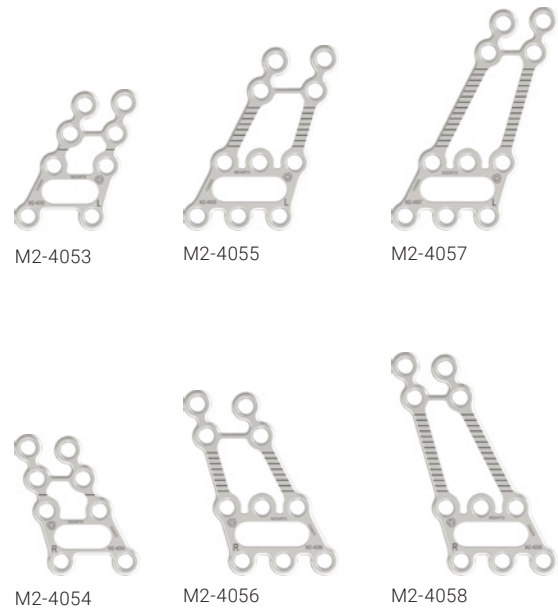

Sliders

M2-5242.08	2.0 Slider, fenestrated 08 mm, HD6
M2-5252.08	2.3 Slider, fenestrated 08 mm, HD6



1. Selecting the plate

After performing the ramus osteotomy, set the occlusion and perform temporary IMF. Select the suitable plate based on the width of the osteotomy split.



2. Bending the plate

If required, use the plate bending pliers with pin (M2-2158) to contour the plate to the patient's bone structure (see section "Bending the Plates"). When using TriLock screws, the benefits of an internal fixator can be used, dispensing with the need for perfect plate contouring.

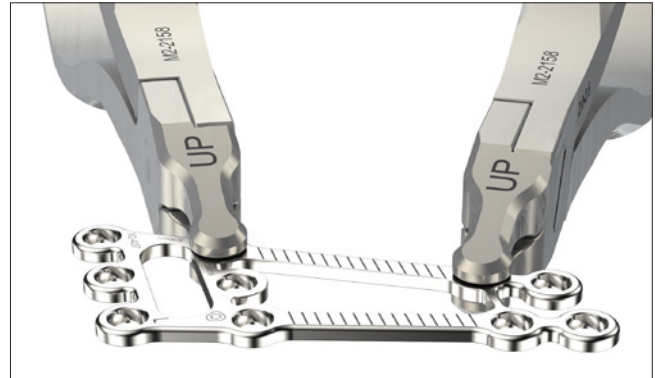

Notice

Only the plates M2-4055, M2-4056, M2-4057, M2-4058 can also be bent with the plate bending pliers M2-2006 in the region of the connecting bars between the cranial and caudal end. In this case, it is important to secure the adjacent plate hole with the plate bending pliers with pin (M2-2158).



3. Cranial fixation

Position the plate. If the displacement is purely horizontal (M2-4053, M2-4054), the laser markings must be positioned over the osteotomy split. Drill the screw holes located in the cranial segment using a twist drill (see section "Drills"). At least three 2.0 TriLock screws must be inserted up to just before the start of the locking procedure in order to prevent the plate from shifting. Once all of the screws have been inserted on the proximal side, they can be locked.

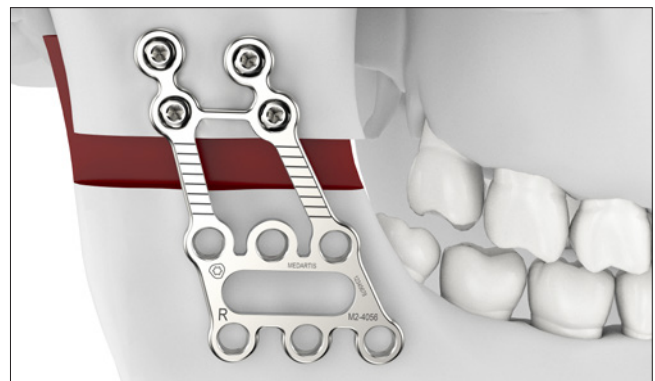

Notice

During the locking procedure, the torque is initially increased during the first phase. This is followed by a brief drop in torque. Only then is a friction connection established to lock the screw as it is tightened.

For details about the TriLock locking process, see section "TriLock Locking Technology".

Case I: Purely horizontal forward or backward displacements (M2-4053, M2-4054)

4a. Positioning the slider

For intraoperative occlusion adjustment with a purely horizontal offset, a slider with a slider fenestration for this purpose can optionally be affixed.

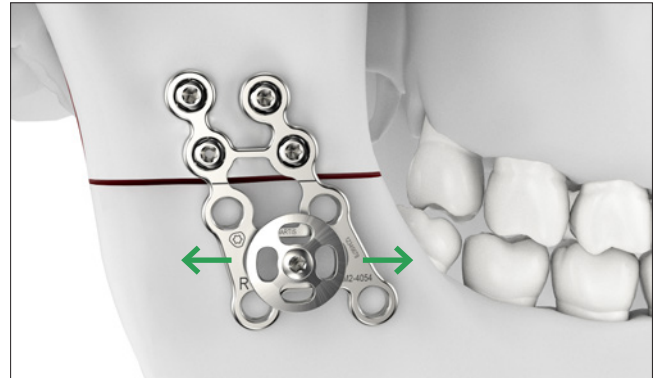

Notice

To affix the slider, predrill with a twist drill (see section "Drills"). Position the slider as centrally as possible so that adjustments can be made in any direction as required.

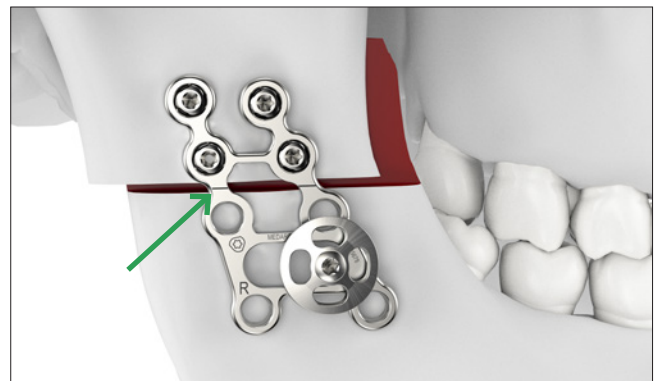

Case II: Vertical displacements and horizontal forward or backward displacements (M2-4055, M2-4056, M2-4057, M2-4058)

4b. Positioning the slider

For intraoperative occlusion adjustment with a combined horizontal/vertical offset, a slider with a slider fenestration for this purpose can optionally be affixed.

Notice

To affix the slider, predrill with a twist drill (see section "Drills"). Position the slider as centrally as possible so that adjustments can be made in any direction as required.

Notice

The laser markings on the implant serve as a vertical positioning guide.

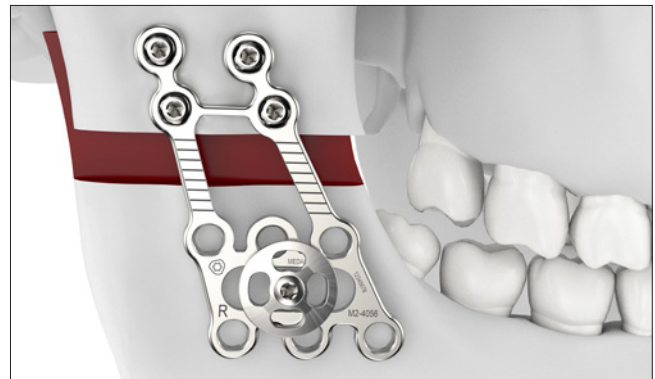

5. Repeat steps 3 and 4 (a or b) on the opposite side of the mandible.

6. Checking the occlusion

Loosen the IMF and check the occlusion. If necessary, make adjustments by loosening the slider and making slight adjustments to the position of the caudal segment. The caudal segment can be adjusted vertically and horizontally. Retighten the slider and check dental and jaw positioning until the desired occlusion is achieved.

Repeat the IMF.

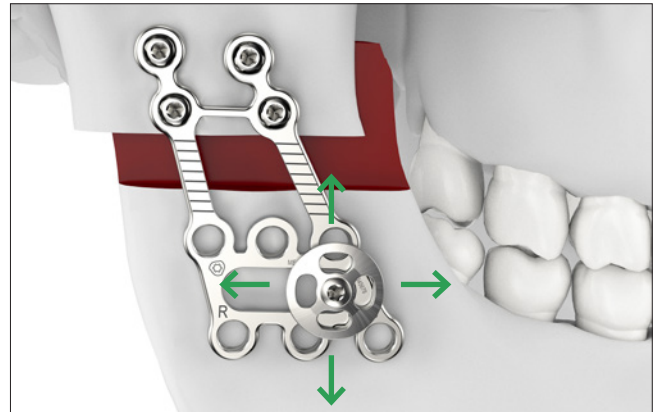

7. Final caudal fixation

Insert screws in the caudal plate holes not covered by the slider (at least 3 holes).

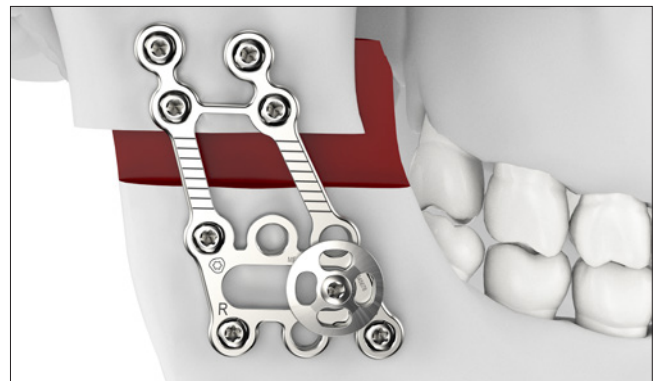

8. Removing the slider

Remove the slider and insert screws in the remaining caudal screw holes.

Caution

The slider is only an intraoperative aid for adjusting the occlusion and must be removed after the osteosynthesis has been completed.

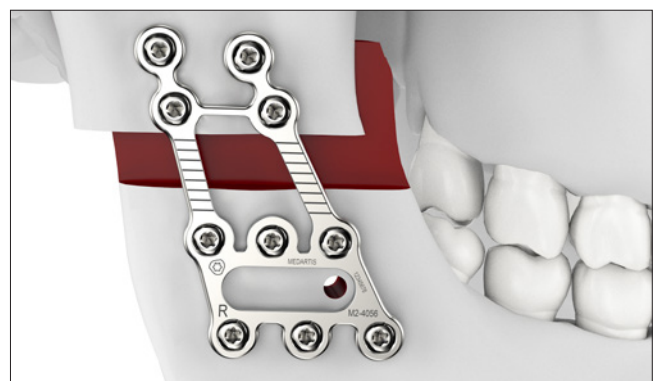

Genioplasty with a Pre-Shaped Chin Plate

The following pre-shaped plates are available for genioplasty:

M2-4074	For chin shortening
M2-4076	For forward and backward chin displacement 3 mm
M2-4078	For forward and backward chin displacement 5 mm
M2-4080	For forward and backward chin displacement 7 mm
M2-4082	For forward and backward chin displacement 10 mm



M2-4074



M2-4076



M2-4078

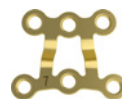

M2-4080

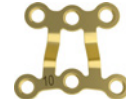

M2-4082

1. Selecting the plate

After performing the osteotomy and positioning the caudal segment, select the plate which best fits with size of the displacement.



2. Bending the plate

If necessary, the plates can be slightly bent with the plate bending pliers with pin (M2-2158).



3. Cranial fixation

Position the plate and drill three cranial screw holes (see section "Drills"). Then insert the screws.



4. Caudal fixation

Position the mobilized segment. Drill the caudal screw holes using a twist drill (see section "Drills") and insert the screws.

Caution

A minimum of two screws must be used on each side of the osteotomy.



For backward chin displacement, perform steps 3 and 4 by means of a plate turned by 180° in the plane.

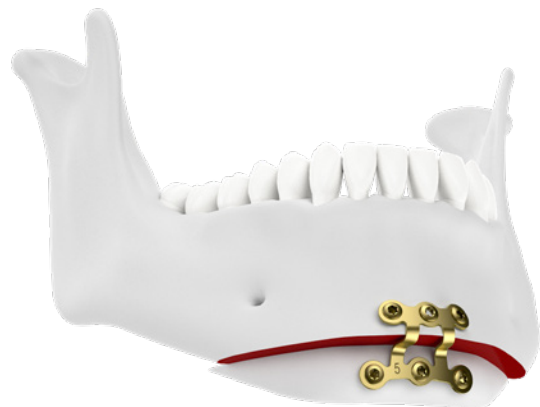

Follow-Up Care and Explantation

Follow-Up Care for MODUS 2 Orthognathics Implants

Taking into account the individual osteotomy or fracture conditions and patient compliance, it is important to ensure adequate postoperative relief of the osteosynthesis in terms of adaptation or mobilization stability (e.g. splinting and/or immobilization). Postoperatively, the fixation achieved with the implants must be treated with care until the bone has fully healed. Patients must closely observe follow-up instructions given by their physicians to avoid detrimental strain on the implants. Premature loading can increase the risk of loosening, migration or breakage of the implant.

Explantation of MODUS 2 Orthognathics Implants

Use the appropriate screwdrivers to remove the screws to explant MODUS 2 Orthognathics implants.

Caution

Only original MODUS 2 Instruments are recommended for the explantation of MODUS 2 implants.

When removing the screws, ensure that any bone ingrowth in the screw head has been removed, that the screwdriver/screw head connection is aligned in axial direction, and that a sufficient axial force is used between blade and screw.

TriLock Locking Technology

Correct Application of the TriLock Locking Technology

The screw is inserted through the plate hole into a predrilled canal in the bone. An increase of the tightening torque will be felt as soon as the screw head makes contact with the plate surface.

This indicates the start of the "Insertion Phase" as the screw head starts entering the locking zone of the plate (section "A" in the diagram). Afterwards, a drop of the tightening torque

occurs (section "B" in the diagram). Finally, the actual locking is initiated (section "C" in the diagram) as a friction connection is established between screw and plate when tightening firmly.

The torque applied during fastening of the screw is decisive for the quality of the locking as described in section "C" of the diagram.

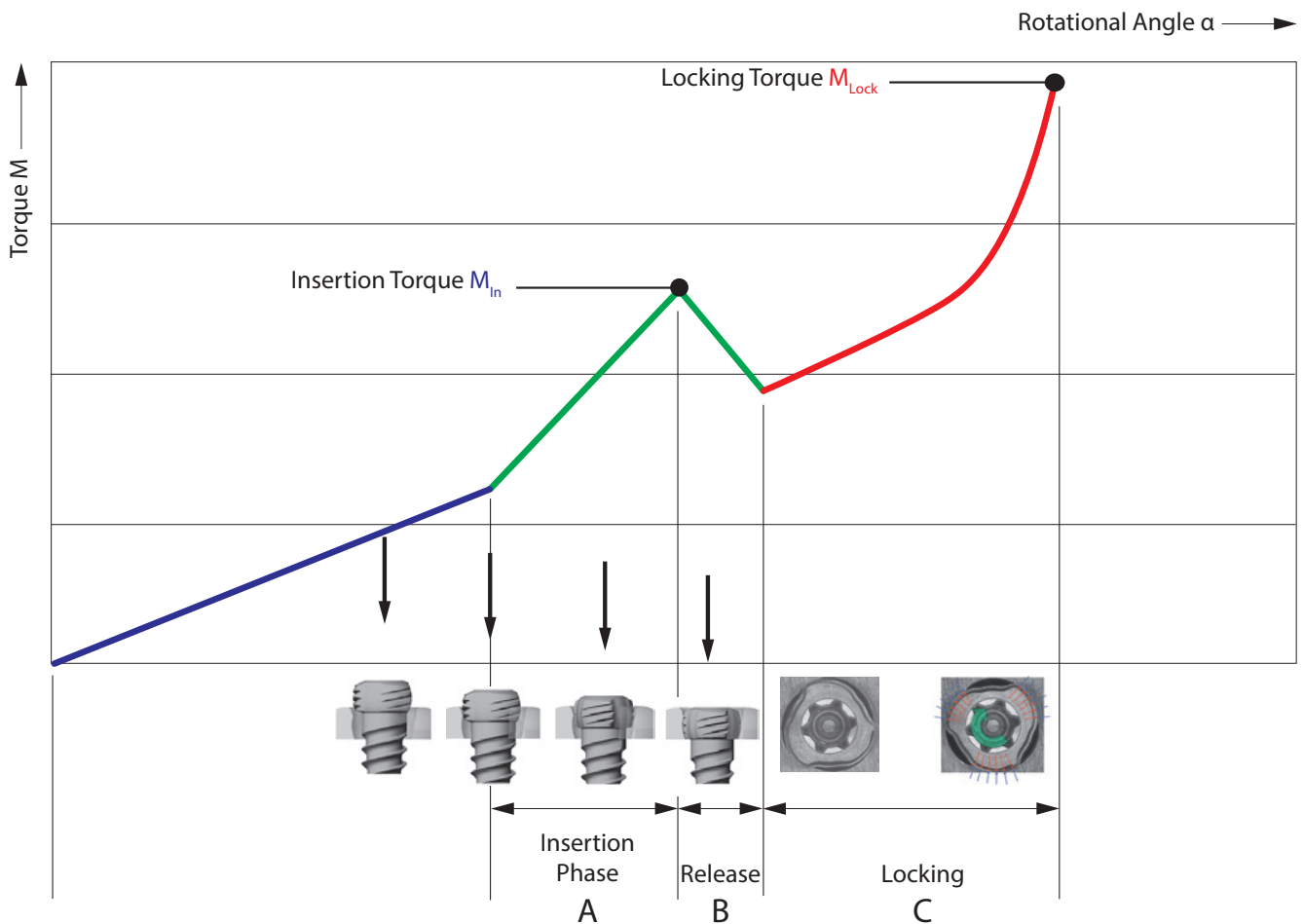

Correct Locking ($\pm 15^\circ$) of the TriLock Screws in the Plate

Correct locking occurs only when the screw head is locked flush with the locking contour (fig. 1 and 3).

bone quality, a slight axial pressure may be necessary to achieve proper locking.

However, if there is still a noticeable protrusion (fig. 2 and 4), the screw head has not completely reached the locking position. In this case, the screw has to be retightened to obtain full penetration and proper locking. In case of poor

After having reached the locking torque (M_{Lock}), do not further tighten the screw, otherwise the locking function cannot be guaranteed anymore.

Correct: LOCKED

Incorrect: UNLOCKED

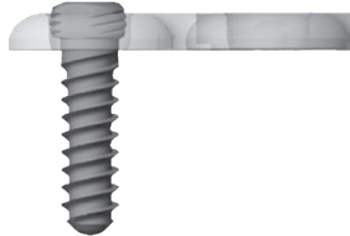
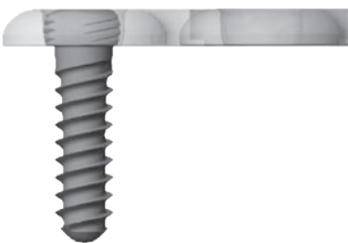

Figure 1

Figure 2

Correct: LOCKED

Incorrect: UNLOCKED

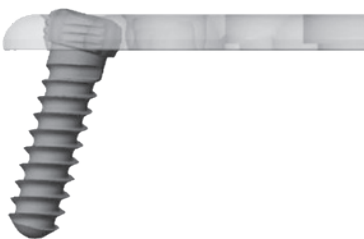

Figure 3

Figure 4

Implants, Instruments and Containers

L Plates

Compatible with screws \varnothing 1.2/1.5/1.8

Material: Titanium (ASTM F67)
Plate thickness: 0.7 mm

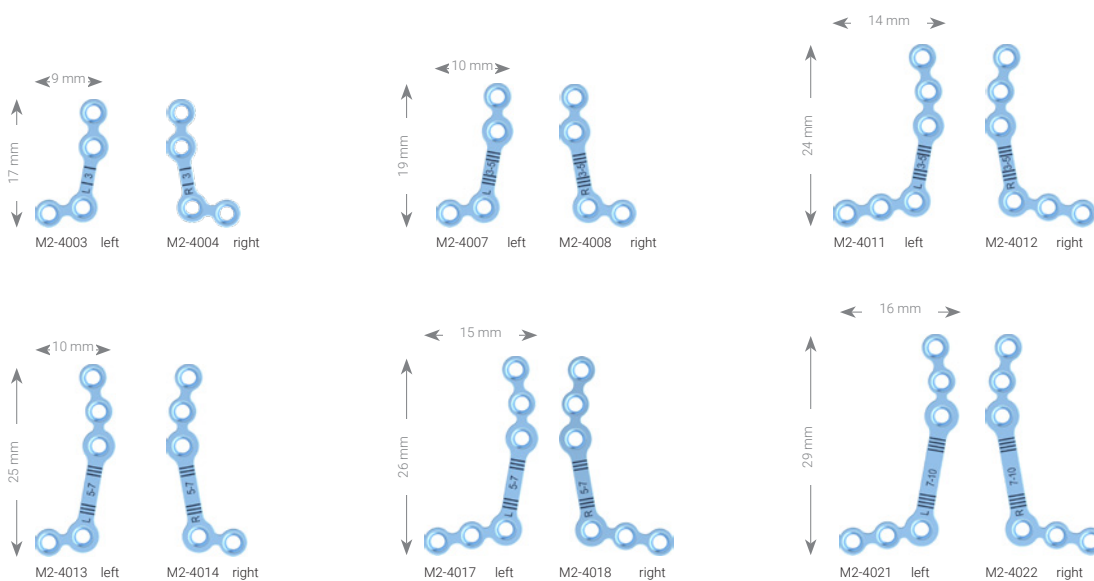

Art. No.	STERILE	Description	Bar	Holes	Pieces / Pkg
M2-4003	M2-4003S	L, left	max. 3 mm	4 (2/2)	1
M2-4004	M2-4004S	L, right	max. 3 mm	4 (2/2)	1
M2-4007	M2-4007S	L, left	max. 5 mm	4 (2/2)	1
M2-4008	M2-4008S	L, right	max. 5 mm	4 (2/2)	1
M2-4011	M2-4011S	L, left	max. 5 mm	6 (3/3)	1
M2-4012	M2-4012S	L, right	max. 5 mm	6 (3/3)	1
M2-4013	M2-4013S	L, left	max. 7 mm	5 (2/3)	1
M2-4014	M2-4014S	L, right	max. 7 mm	5 (2/3)	1
M2-4017	M2-4017S	L, left	max. 7 mm	6 (3/3)	1
M2-4018	M2-4018S	L, right	max. 7 mm	6 (3/3)	1
M2-4021	M2-4021S	L, left	max. 10 mm	6 (3/3)	1
M2-4022	M2-4022S	L, right	max. 10 mm	6 (3/3)	1

Maxillary Plates, Pre-Shaped, Single Arm

Compatible with screws \varnothing 1.2/1.5/1.8

Material: Titanium (ASTM F67)
Plate thickness: 0.7 mm

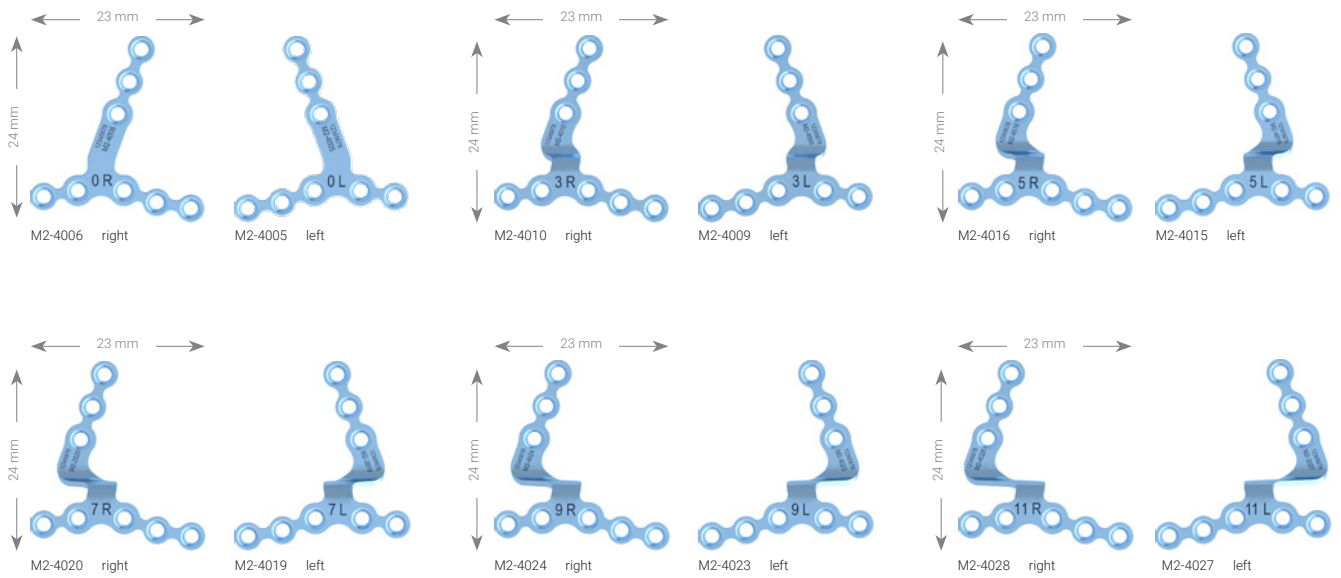

Art. No.	STERILE	Description	Bar	Holes	Pieces / Pkg
M2-4005	M2-4005S	LeFort I, left	0 mm	8	1
M2-4006	M2-4006S	LeFort I, right	0 mm	8	1
M2-4009	M2-4009S	LeFort I, left	3 mm	8	1
M2-4010	M2-4010S	LeFort I, right	3 mm	8	1
M2-4015	M2-4015S	LeFort I, left	5 mm	8	1
M2-4016	M2-4016S	LeFort I, right	5 mm	8	1
M2-4019	M2-4019S	LeFort I, left	7 mm	8	1
M2-4020	M2-4020S	LeFort I, right	7 mm	8	1
M2-4023	M2-4023S	LeFort I, left	9 mm	8	1
M2-4024	M2-4024S	LeFort I, right	9 mm	8	1
M2-4027	M2-4027S	LeFort I, left	11 mm	8	1
M2-4028	M2-4028S	LeFort I, right	11 mm	8	1

Maxillary Plates, Pre-Shaped, Two Arms

Compatible with screws \varnothing 1.2/1.5/1.8

Material: Titanium (ASTM F67)
Plate thickness: 0.7 mm

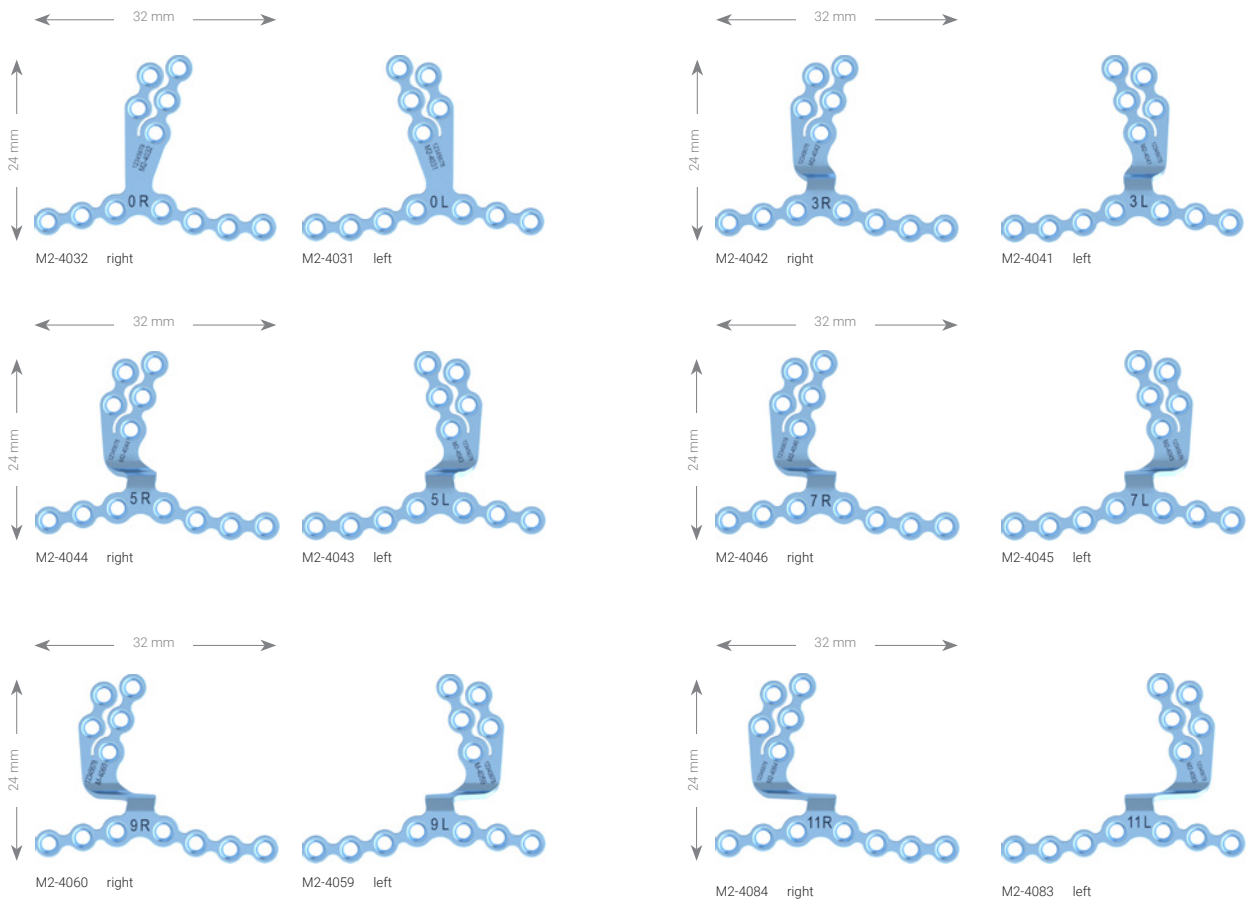

Art. No.	STERILE	Description	Bar	Holes	Pieces / Pkg
M2-4031	M2-4031S	LeFort I, left	0 mm	12	1
M2-4032	M2-4032S	LeFort I, right	0 mm	12	1
M2-4041	M2-4041S	LeFort I, left	3 mm	12	1
M2-4042	M2-4042S	LeFort I, right	3 mm	12	1
M2-4043	M2-4043S	LeFort I, left	5 mm	12	1
M2-4044	M2-4044S	LeFort I, right	5 mm	12	1
M2-4045	M2-4045S	LeFort I, eft	7 mm	12	1
M2-4046	M2-4046S	LeFort I, right	7 mm	12	1
M2-4059	M2-4059S	LeFort I, left	9 mm	12	1
M2-4060	M2-4060S	LeFort I, right	9 mm	12	1
M2-4083	M2-4083S	LeFort I, left	11 mm	12	1
M2-4084	M2-4084S	LeFort I, right	11 mm	12	1

Z Plates, Lateral

Compatible with screws \varnothing 1.2/1.5/1.8

Material: Titanium (ASTM F67)
Plate thickness: 0.7 mm

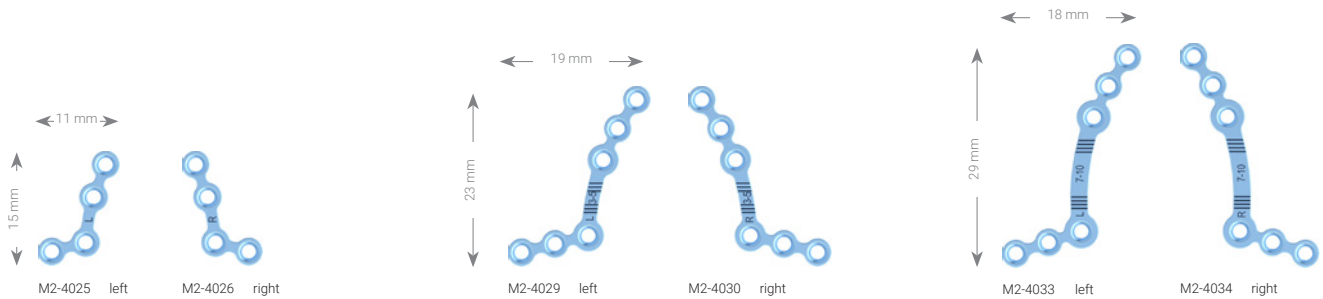

Art. No.	STERILE	Description	Bar	Holes	Pieces / Pkg
M2-4025	M2-4025S	Z, left	0 mm	4 (2/2)	1
M2-4026	M2-4026S	Z, right	0 mm	4 (2/2)	1
M2-4029	M2-4029S	Z, left	max. 5 mm	6 (3/3)	1
M2-4030	M2-4030S	Z, right	max. 5 mm	6 (3/3)	1
M2-4033	M2-4033S	Z, left	max. 10 mm	6 (3/3)	1
M2-4034	M2-4034S	Z, right	max. 10 mm	6 (3/3)	1

Y Plates

Compatible with screws \varnothing 1.2/1.5/1.8

Material: Titanium (ASTM F67)
Plate thickness: 0.7 mm

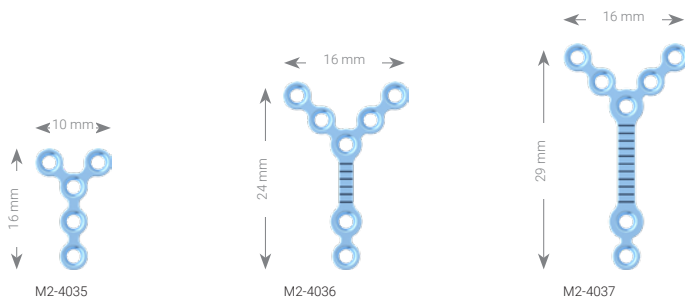

Art. No.	STERILE	Description	Bar	Holes	Pieces / Pkg
M2-4035	M2-4035S	Y	0 mm	5 (2/3)	1
M2-4036	M2-4036S	Y	max. 5 mm	7 (4/3)	1
M2-4037	M2-4037S	Y	max. 10 mm	7 (4/3)	1

Orthognathics Midface Plates

Compatible with screws \varnothing 1.2/1.5/1.8

Material: Titanium (ASTM F67)
Plate thickness: 0.7 mm

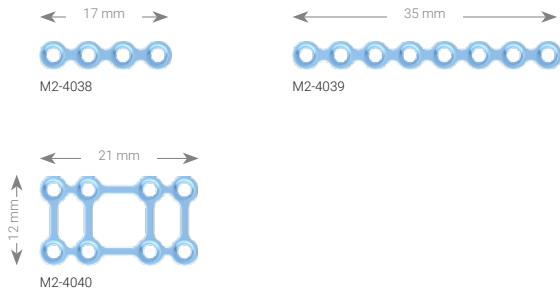

Art. No.	STERILE	Description	Holes	Pieces / Pkg
M2-4038	M2-4038S	straight	4	1
M2-4039	M2-4039S	straight	8	1
M2-4040	M2-4040S	Grid, rectangular	8 (4x2)	1

Sagittal Split Plates

Compatible with screws \varnothing 2.0/2.3

Material: Titanium (ASTM F67)
Plate thickness: 0.7 mm, 0.8 mm

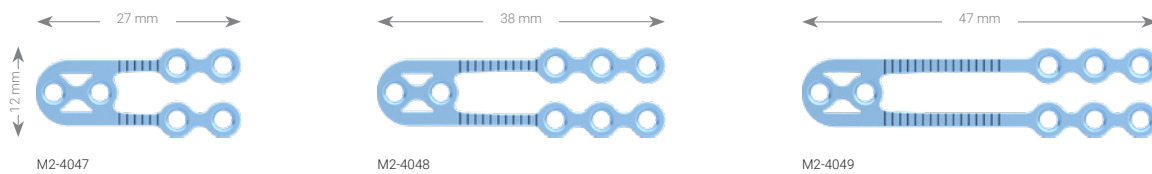

Art. No.	STERILE	Description	Plate Thickness	Bar	Holes	Pieces / Pkg
M2-4047	M2-4047S	open	0.7 mm	max. 5 mm	6	1
M2-4048	M2-4048S	open	0.7 mm	max. 10 mm	8	1
M2-4049	M2-4049S	open	0.8 mm	max. 15 mm	8	1

Sagittal Split Plates

Compatible with screws \varnothing 2.0/2.3

Material: Titanium (ASTM F67)
Plate thickness: 0.8 mm, 0.9 mm, 1.0 mm

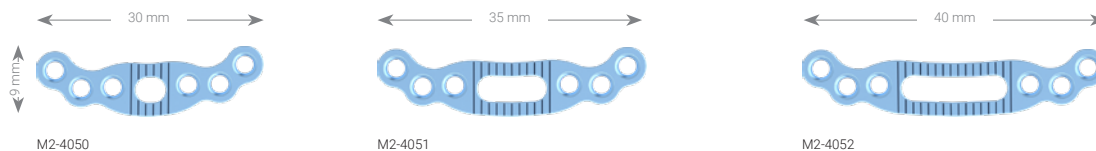

Art. No.	STERILE	Description	Plate Thickness	Bar	Holes	Pieces / Pkg
M2-4050	M2-4050S	closed	0.8 mm	max. 5 mm	6	1
M2-4051	M2-4051S	closed	0.9 mm	max. 10 mm	6	1
M2-4052	M2-4052S	closed	1.0 mm	max. 15 mm	6	1

Sagittal Split Plates

Compatible with screws \varnothing 2.0/2.3

Material: Titanium (ASTM F67)
Plate thickness: 1.0 mm

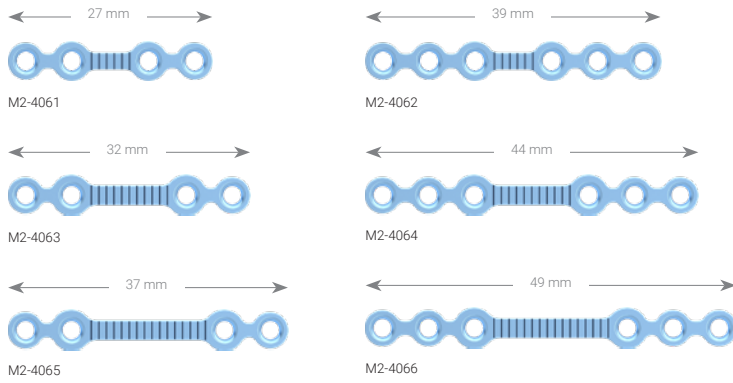

Art. No.	STERILE	Description	Bar	Holes	Pieces / Pkg
M2-4061	M2-4061S	straight	max. 5 mm	4	1
M2-4062	M2-4062S	straight	max. 5 mm	6	1
M2-4063	M2-4063S	straight	max. 10 mm	4	1
M2-4064	M2-4064S	straight	max. 10 mm	6	1
M2-4065	M2-4065S	straight	max. 15 mm	4	1
M2-4066	M2-4066S	straight	max. 15 mm	6	1

TriLock Ramus Plates

Compatible with screws Ø 2.0/2.3

Material: Titanium (ASTM F67)
Plate thickness: 1.3 mm

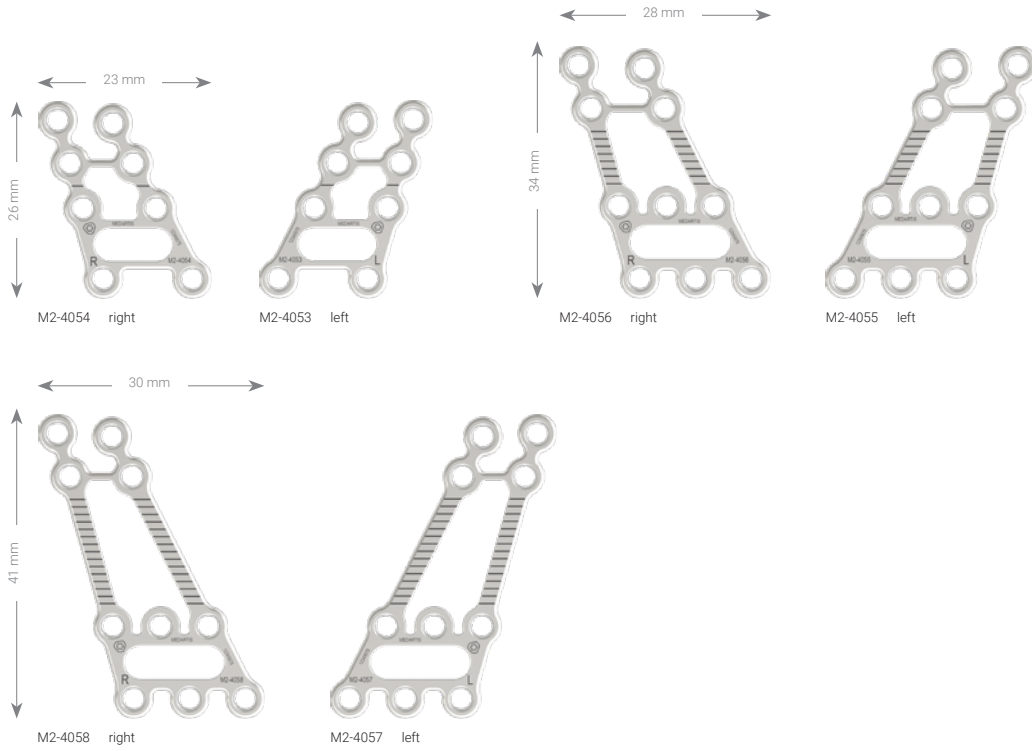

Art. No.	STERILE	Description	Bar	Holes	Pieces / Pkg
M2-4053	M2-4053S	left	0 mm	8	1
M2-4054	M2-4054S	right	0 mm	8	1
M2-4055	M2-4055S	left	max. 7 mm	10	1
M2-4056	M2-4056S	right	max. 7 mm	10	1
M2-4057	M2-4057S	left	max. 14 mm	10	1
M2-4058	M2-4058S	right	max. 14 mm	10	1

Chin Plates

Compatible with screws Ø 2.0/2.3

Material: Titanium (ASTM F67)
Plate thickness: 1.0 mm

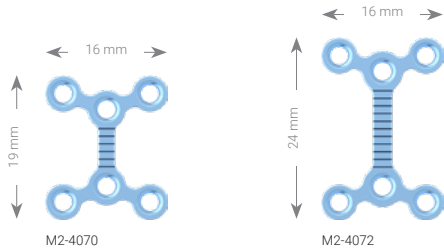

Art. No.	STERILE	Description	Bar	Holes	Pieces / Pkg
M2-4070	M2-4070S	X	max. 5 mm	6	1
M2-4072	M2-4072S	X	max. 10 mm	6	1

Chin Plates

Compatible with screws Ø 2.0/2.3

Material: Titanium (ASTM F67)
Plate thickness: 0.6 mm

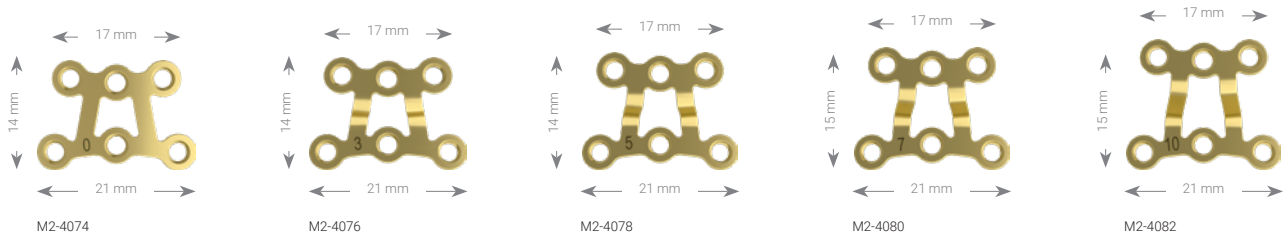

Art. No.	STERILE	Description	Bar	Holes	Pieces / Pkg
M2-4074	M2-4074S	flat	0 mm	6	1
M2-4076	M2-4076S	pre-shaped	3 mm	6	1
M2-4078	M2-4078S	pre-shaped	5 mm	6	1
M2-4080	M2-4080S	pre-shaped	7 mm	6	1
M2-4082	M2-4082S	pre-shaped	10 mm	6	1

Orthognathics Mandible Plates

Compatible with screws Ø 2.0/2.3

Material: Titanium (ASTM F67)
Plate thickness: 1.0 mm

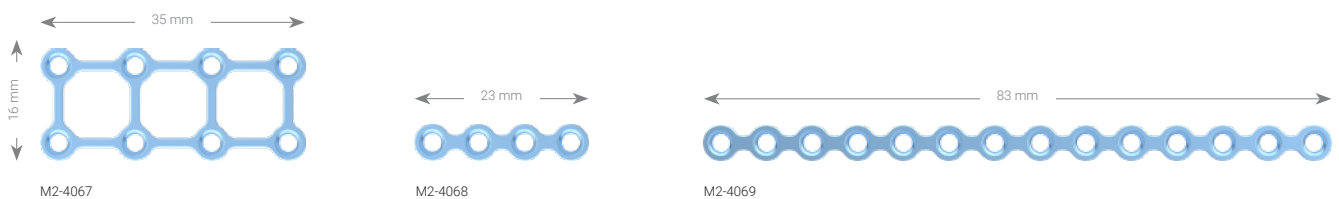

Art. No.	STERILE	Description	Holes	Pieces / Pkg
M2-4067	M2-4067S	Grid, square	8 (4x2)	1
M2-4068	M2-4068S	straight	4	1
M2-4069	M2-4069S	straight	14	1

1.2 Cortical Screws, HexaDrive 4

Material: Titanium alloy (ASTM F136)



Length	Art. No.	STERILE	Pieces / Pkg
4 mm	M2-5214.04/1	M2-5214.04/1S	1
5 mm	M2-5214.05/1	M2-5214.05/1S	1
6 mm	M2-5214.06/1	M2-5214.06/1S	1
7 mm	M2-5214.07/1	M2-5214.07/1S	1
8 mm	M2-5214.08/1	M2-5214.08/1S	1
9 mm	M2-5214.09/1	M2-5214.09/1S	1
11 mm	M2-5214.11/1	M2-5214.11/1S	1

Art. No.	Pieces / Pkg
M2-5214.04	5
M2-5214.05	5
M2-5214.06	5
M2-5214.07	5
M2-5214.08	5
M2-5214.09	5
M2-5214.11	5

1.5 Cortical Screws, HexaDrive 4

Material: Titanium alloy (ASTM F136)

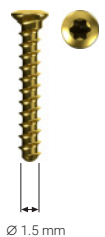

Length	Art. No.	STERILE	Pieces / Pkg
4 mm	M2-5224.04/1	M2-5224.04/1S	1
5 mm	M2-5224.05/1	M2-5224.05/1S	1
6 mm	M2-5224.06/1	M2-5224.06/1S	1
7 mm	M2-5224.07/1	M2-5224.07/1S	1
8 mm	M2-5224.08/1	M2-5224.08/1S	1
9 mm	M2-5224.09/1	M2-5224.09/1S	1
11 mm	M2-5224.11/1	M2-5224.11/1S	1

Art. No.	Pieces / Pkg
M2-5224.04	5
M2-5224.05	5
M2-5224.06	5
M2-5224.07	5
M2-5224.08	5
M2-5224.09	5
M2-5224.11	5

1.5 SpeedTip Screws, HexaDrive 4

Material: Titanium alloy (ASTM F136)



Length	Art. No.	STERILE	Pieces / Pkg
4 mm	M2-5223.04/1	M2-5223.04/1S	1
5 mm	M2-5223.05/1	M2-5223.05/1S	1
6 mm	M2-5223.06/1	M2-5223.06/1S	1
7 mm	M2-5223.07/1	M2-5223.07/1S	1
8 mm	M2-5223.08/1	M2-5223.08/1S	1
9 mm	M2-5223.09/1	M2-5223.09/1S	1

Art. No.	Pieces / Pkg
M2-5223.04	5
M2-5223.05	5
M2-5223.06	5
M2-5223.07	5
M2-5223.08	5
M2-5223.09	5

1.8 Cortical Screws, HexaDrive 4

Material: Titanium alloy (ASTM F136)



Length	Art. No.	STERILE	Pieces / Pkg
4 mm	M2-5234.04/1	M2-5234.04/1S	1
5 mm	M2-5234.05/1	M2-5234.05/1S	1
6 mm	M2-5234.06/1	M2-5234.06/1S	1
7 mm	M2-5234.07/1	M2-5234.07/1S	1
8 mm	M2-5234.08/1	M2-5234.08/1S	1
9 mm	M2-5234.09/1	M2-5234.09/1S	1
11 mm	M2-5234.11/1	M2-5234.11/1S	1

Art. No.	Pieces / Pkg
M2-5234.04	5
M2-5234.05	5
M2-5234.06	5
M2-5234.07	5
M2-5234.08	5
M2-5234.09	5
M2-5234.11	5

2.0 Cortical Screws, HexaDrive 6

Material: Titanium alloy (ASTM F136)

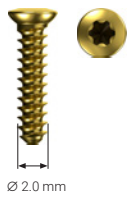

Length	Art. No.	STERILE	Pieces / Pkg
5 mm	M2-5240.05/1	M2-5240.05/1S	1
7 mm	M2-5240.07/1	M2-5240.07/1S	1
9 mm	M2-5240.09/1	M2-5240.09/1S	1
11 mm	M2-5240.11/1	M2-5240.11/1S	1
13 mm	M2-5240.13/1	M2-5240.13/1S	1
15 mm	M2-5240.15/1	M2-5240.15/1S	1
17 mm	M2-5240.17/1	M2-5240.17/1S	1
19 mm	M2-5240.19/1	M2-5240.19/1S	1
21 mm	M2-5240.21/1	M2-5240.21/1S	1
23 mm	M2-5240.23/1	M2-5240.23/1S	1

Art. No.	Pieces / Pkg
M2-5240.05	5
M2-5240.07	5
M2-5240.09	5
M2-5240.11	5
M2-5240.13	5
M2-5240.15	5
M2-5240.17	5
M2-5240.19	5
M2-5240.21	5
M2-5240.23	5

2.0 SpeedTip Screws, Self-Drilling, HexaDrive 6

Material: Titanium alloy (ASTM F136)

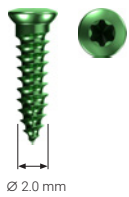

Length	Art. No.	STERILE	Pieces / Pkg
5 mm	M2-5243.05/1	M2-5243.05/1S	1
7 mm	M2-5243.07/1	M2-5243.07/1S	1
9 mm	M2-5243.09/1	M2-5243.09/1S	1
11 mm	M2-5243.11/1	M2-5243.11/1S	1

Art. No.	Pieces / Pkg
M2-5243.05	5
M2-5243.07	5
M2-5243.09	5
M2-5243.11	5

2.0 TriLock Screws, HexaDrive 6

Material: Titanium alloy (ASTM F136)

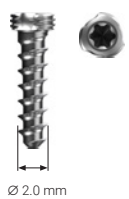

Length	Art. No.	STERILE	Pieces / Pkg
5 mm	M2-5245.05/1	M2-5245.05/1S	1
6 mm	M2-5245.06/1	M2-5245.06/1S	1
7 mm	M2-5245.07/1	M2-5245.07/1S	1
8 mm	M2-5245.08/1	M2-5245.08/1S	1
9 mm	M2-5245.09/1	M2-5245.09/1S	1

Art. No.	Pieces / Pkg
M2-5245.05	5
M2-5245.06	5
M2-5245.07	5
M2-5245.08	5
M2-5245.09	5

2.3 Cortical Screws, HexaDrive 6

Material: Titanium alloy (ASTM F136)

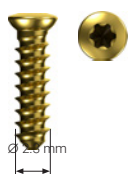

Length	Art. No.	STERILE	Pieces / Pkg
5 mm	M2-5250.05/1	M2-5250.05/1S	1
7 mm	M2-5250.07/1	M2-5250.07/1S	1
9 mm	M2-5250.09/1	M2-5250.09/1S	1

Art. No.	Pieces / Pkg
M2-5250.05	5
M2-5250.07	5
M2-5250.09	5

Slider, Fenestrated, HexaDrive 6

Material: Titanium alloy (ASTM F136)

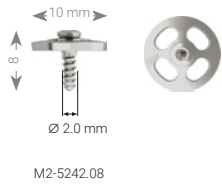

Length	Ø.	Art. No.	STERILE	Pieces / Pkg
8 mm	2.0 mm	M2-5242.08	M2-5242.08S	1
8 mm	2.3 mm	M2-5252.08	M2-5252.08S	1

Twist Drills Ø 1.0 mm (Core Hole 1.2 Screws)



M2-3012



M2-3032



M2-3052



M2-3382



M2-3022



M2-3042



M2-3062



M2-3392

Art. No.	STERILE	Description	Stop	Length	Shaft End	Pieces / Pkg
M2-3012	M2-3012S		5 mm	35 mm	Dental	1
M2-3022	M2-3022S		5 mm	48 mm	Stryker J-Latch	1
M2-3032	M2-3032S		7 mm	37 mm	Dental	1
M2-3042	M2-3042S		7 mm	50 mm	Stryker J-Latch	1
M2-3052	M2-3052S		25 mm	55 mm	Dental	1
M2-3062	M2-3062S		25 mm	68 mm	Stryker J-Latch	1
M2-3382	M2-3382S	for drill guide M2-2202	25 mm	99 mm	Dental	1
M2-3392	M2-3392S	for drill guide M2-2202	25 mm	112 mm	Stryker J-Latch	1

Twist Drills Ø 1.2 mm (Gliding Hole 1.2 Screws)



Art. No.	STERILE	Description	Stop	Length	Shaft End	Pieces / Pkg
M2-3072	M2-3072S		25 mm	55 mm	Dental	1
M2-3082	M2-3082S		25 mm	68 mm	Stryker J-Latch	1
M2-3322	M2-3322S	for drill guide M2-2202	25 mm	99 mm	Dental	1
M2-3332	M2-3332S	for drill guide M2-2202	25 mm	112 mm	Stryker J-Latch	1

Twist Drills Ø 1.2 mm (Core Hole 1.5 Screws)

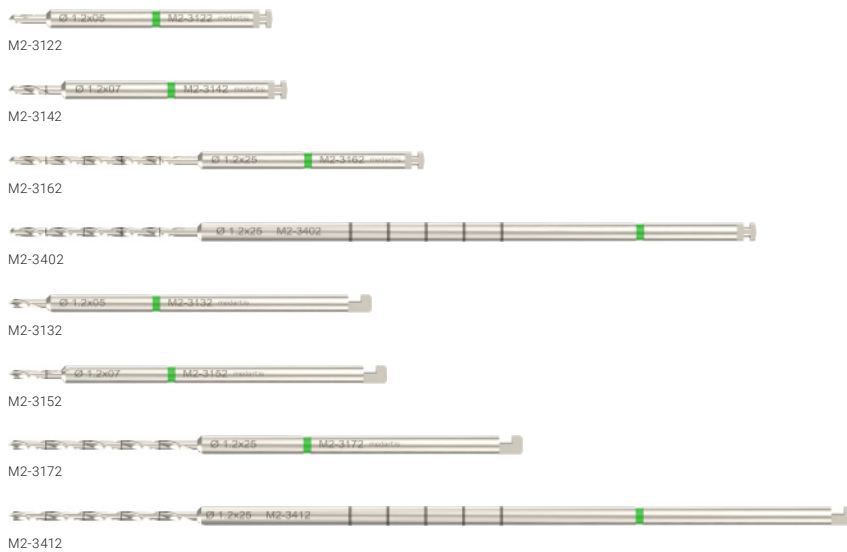

Art. No.	STERILE	Description	Stop	Length	Shaft End	Pieces / Pkg
M2-3122	M2-3122S		5 mm	35 mm	Dental	1
M2-3132	M2-3132S		5 mm	48 mm	Stryker J-Latch	1
M2-3142	M2-3142S		7 mm	37 mm	Dental	1
M2-3152	M2-3152S		7 mm	50 mm	Stryker J-Latch	1
M2-3162	M2-3162S		25 mm	55 mm	Dental	1
M2-3172	M2-3172S		25 mm	68 mm	Stryker J-Latch	1
M2-3402	M2-3402S	for drill guide M2-2202	25 mm	99 mm	Dental	1
M2-3412	M2-3412S	for drill guide M2-2202	25 mm	112 mm	Stryker J-Latch	1

Twist Drills Ø 1.5 mm (Gliding Hole 1.5 Screws)



Art. No.	STERILE	Description	Stop	Length	Shaft End	Pieces / Pkg
M2-3182	M2-3182S		25 mm	55 mm	Dental	1
M2-3192	M2-3192S		25 mm	68 mm	Stryker J-Latch	1
M2-3342	M2-3342S	for drill guide M2-2202	25 mm	99 mm	Dental	1
M2-3352	M2-3352S	for drill guide M2-2202	25 mm	112 mm	Stryker J-Latch	1

Twist Drills Ø 1.5 mm (Core Hole 1.8 Screws)

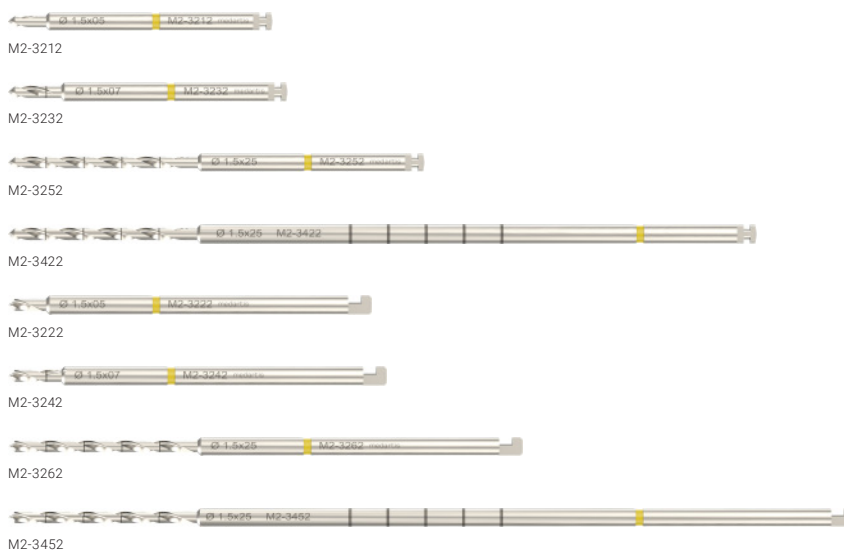

Art. No.	STERILE	Description	Stop	Length	Shaft End	Pieces / Pkg
M2-3212	M2-3212S		5 mm	35 mm	Dental	1
M2-3222	M2-3222S		5 mm	48 mm	Stryker J-Latch	1
M2-3232	M2-3232S		7 mm	37 mm	Dental	1
M2-3242	M2-3242S		7 mm	50 mm	Stryker J-Latch	1
M2-3252	M2-3252S		25 mm	55 mm	Dental	1
M2-3262	M2-3262S		25 mm	68 mm	Stryker J-Latch	1
M2-3422	M2-3422S	for drill guide M2-2202	25 mm	99 mm	Dental	1
M2-3452	M2-3452S	for drill guide M2-2202	25 mm	112 mm	Stryker J-Latch	1

Twist Drills Ø 1.8 mm (Gliding Hole 1.8 Screws)



M2-3272



M2-3362



M2-3282



M2-3372

Art. No.	STERILE	Description	Stop	Length	Shaft End	Pieces / Pkg
M2-3362	M2-3362S	for drill guide M2-2202	25 mm	99 mm	Dental	1
M2-3272	M2-3272S		25 mm	55 mm	Dental	1
M2-3282	M2-3282S		25 mm	68 mm	Stryker J-Latch	1
M2-3372	M2-3372S	for drill guide M2-2202	25 mm	112 mm	Stryker J-Latch	1

Twist Drills Ø 1.5 mm (Core Hole 2.0 Screws)



M2-3119



M2-3139



M2-3159



M2-3459



M2-3129



M2-3149



M2-3169



M2-3469

Art. No.	STERILE	Description	Stop	Length	Shaft End	Pieces / Pkg
M2-3119	M2-3119S		5 mm	35 mm	Dental	1
M2-3129	M2-3129S		5 mm	48 mm	Stryker J-Latch	1
M2-3139	M2-3139S		7 mm	37 mm	Dental	1
M2-3149	M2-3149S		7 mm	50 mm	Stryker J-Latch	1
M2-3159	M2-3159S		25 mm	55 mm	Dental	1
M2-3169	M2-3169S		25 mm	68 mm	Stryker J-Latch	1
M2-3459	M2-3459S	for drill guide M2-2198	25 mm	99 mm	Dental	1
M2-3469	M2-3469S	for drill guide M2-2198	25 mm	112 mm	Stryker J-Latch	1

Twist Drills Ø 2.0 mm (Gliding Hole 2.0 Screws)



M2-3156



M2-3296



M2-3166



M2-3306

Art. No.	STERILE	Description	Stop	Length	Shaft End	Pieces / Pkg
M2-3156	M2-3156S		25 mm	55 mm	Dental	1
M2-3166	M2-3166S		25 mm	68 mm	Stryker J-Latch	1
M2-3296	M2-3296S	for drill guide M2-2198	25 mm	99 mm	Dental	1
M2-3306	M2-3306S	for drill guide M2-2198	25 mm	112 mm	Stryker J-Latch	1

Twist Drills Ø 1.9 mm (Core Hole 2.3 Screws)



M2-3176



M2-3196



M2-3216



M2-3186



M2-3206



M2-3226

Art. No.	STERILE	Description	Stop	Length	Shaft End	Pieces / Pkg
M2-3176	M2-3176S		7 mm	37 mm	Dental	1
M2-3186	M2-3186S		7 mm	50 mm	Stryker J-Latch	1
M2-3196	M2-3196S		25 mm	55 mm	Dental	1
M2-3206	M2-3206S		25 mm	68 mm	Stryker J-Latch	1
M2-3216	M2-3216S	for drill guide M2-2198	25 mm	99 mm	Dental	1
M2-3226	M2-3226S	for drill guide M2-2198	25 mm	112 mm	Stryker J-Latch	1

Twist Drills Ø 2.3 mm (Gliding Hole 2.3 Screws)



M2-3336



M2-3316



M2-3346



M2-3326

Art. No.	STERILE	Description	Stop	Length	Shaft End	Pieces / Pkg
M2-3316	M2-3316S	for drill guide M2-2198	25 mm	99 mm	Dental	1
M2-3326	M2-3326S	for drill guide M2-2198	25 mm	112 mm	Stryker J-Latch	1
M2-3336	M2-3336S		25 mm	55 mm	Dental	1
M2-3346	M2-3346S		25 mm	68 mm	Stryker J-Latch	1

Drill Guides



M2-2202 1:2



M2-2198 1:2

Art. No.	Size	Length	Pieces / Pkg
M2-2202	1.2-1.8	164 mm	1
M2-2198	2.0-2.5	122 mm	1

Depth Gauge



M2-2250 1:2

Art. No.	Size	Description	Length	Pieces / Pkg
M2-2250	1.2-2.3		153 mm	1

Plate Cutting Pliers

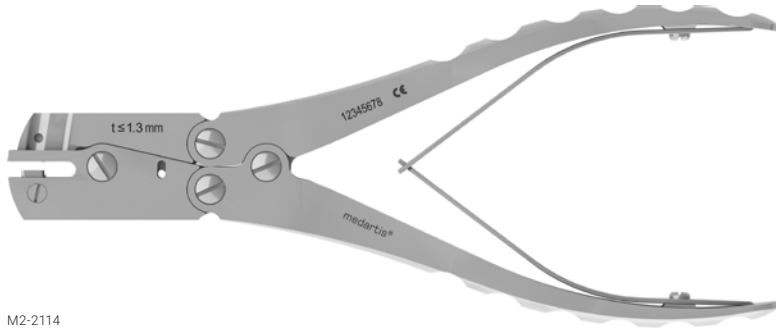

M2-2114



A-2046

Art. No.	Size	Description	Length	Pieces / Pkg
M2-2114		t ≤ 1.3 mm	204 mm	1
A-2046	1.2–2.8		207 mm	1

Containers

Plates



M2-6001.010
(excl. implants)



M2-6001.019
(excl. implants)



M2-6001.020
(excl. implants)



M2-6001.021
(excl. implants)

Art. No.	Description	Dimensions (W x L)	Pieces / Pkg
M2-6001.010	Implant Case, ORTHOGNATHICS MANDIBLE Plates	120 x 240 mm	1
M2-6001.019	Implant Case, ORTHOGNATHICS MIDFACE Plates	120 x 240 mm	1
M2-6001.020	Implant Case, ORTHOGNATHICS MIDFACE Plates	120 x 240 mm	1
M2-6001.021	Implant Case, ORTHOGNATHICS MIDFACE Plates	120 x 240 mm	1
M-6726	Lid f. Implant and Instr.Case 120 x 240 mm	120 x 240 mm	1

Screws

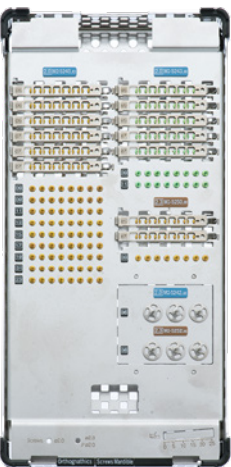

M2-6001.013 and
M2-6001.014 (excl. implants)

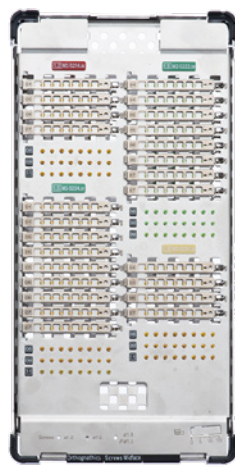

M2-6001.022 and
M2-6001.023 (excl. implants)



M2-6001.024 and
M2-6001.025 (excl. implants)

Art. No.	Description	Dimensions (W x L)	Pieces / Pkg
M2-6001.013	Implant Case, ORTHOGNATHICS MANDIBLE Screws	120 x 240 mm	1
M2-6001.014	Screw Tray, ORTHOGNATHICS MANDIBLE Screws	120 x 240 mm	1
M2-6001.022	Implant Case, ORTHOGNATHICS MIDFACE Screws	120 x 240 mm	1
M2-6001.023	Screw Tray, ORTHOGNATHICS MIDFACE Screws	120 x 240 mm	1
M2-6001.024	Implant Case, ORTHOGNATHICS MIDFACE Screws	120 x 240 mm	1
M2-6001.025	Screw Tray, ORTHOGNATHICS MIDFACE Screws	120 x 240 mm	1
M-6726	Lid f. Implant and Instr.Case 120 x 240 mm	120 x 240 mm	1

Plates & Screws combined:



M2-6001.008 and M2-6001.009
(excl. implants)

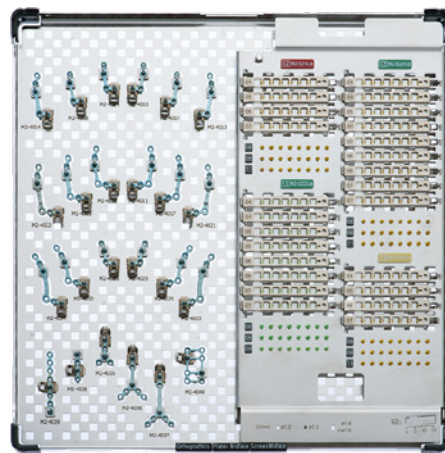

M2-6001.015 and M2-6001.016
(excl. implants)

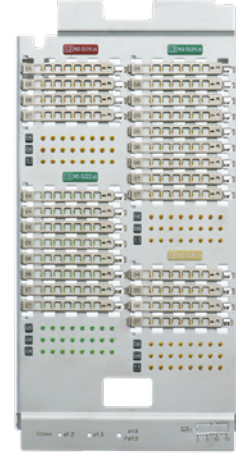

M2-6001.016

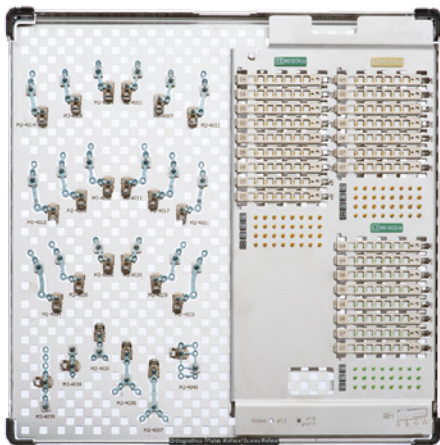

M2-6001.017 and M2-6001.018
(excl. implants)



M2-6001.018

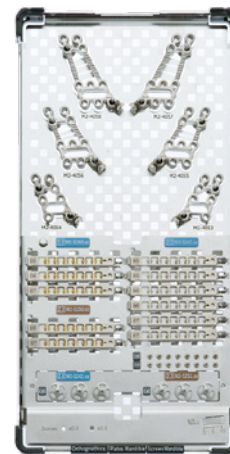

M2-6001.011 and M2-6001.012
(excl. implants)

Art. No.	Description	Dimensions (W x L)	Pieces / Pkg
M2-6001.008	Implant Case, ORTHOGNATHICS MANDIBLE Plates / Screws	240 x 240 mm	1
M2-6001.009	Screw Tray, ORTHOGNATHICS MANDIBLE Screws	120 x 142 mm	1
M2-6001.015	Implant Case, ORTHOGNATHICS MIDFACE Plates / Screws	240 x 240 mm	1
M2-6001.016	Screw Tray, ORTHOGNATHICS MIDFACE Screws	120 x 240 mm	1
M2-6001.017	Implant Case, ORTHOGNATHICS MIDFACE Plates / Screws	240 x 240 mm	1
M2-6001.018	Screw Tray, ORTHOGNATHICS MIDFACE Screws	120 x 240 mm	1
M2-6001.011	Implant Case, ORTHOGNATHICS MANDIBLE Plates / Screws	120 x 240 mm	1
M2-6001.012	Screw Tray, ORTHOGNATHICS MANDIBLE Screws	120 x 112 mm	1
M-6726	Lid f. Implant and Instr. Case 120 x 240 mm	120 x 240 mm	1
M-6727	Lid f. Implant and Instr. Case 240 x 240 mm	240 x 240 mm	1

Instruments



M2-6001.001 with M2-6001.003* / M2-6001.005*, M2-6001.006 and M2-6001.007 (excl. instruments)

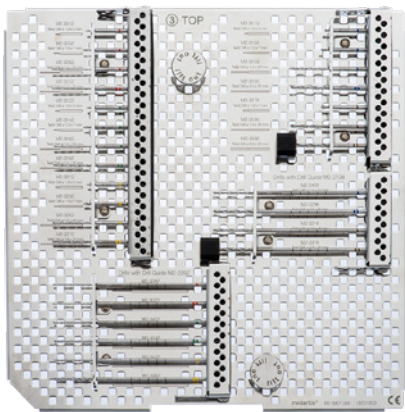

M2-6001.003*



M2-6001.006



M2-6001.007

Art. No.	Description	Dimensions (W x L)	Pieces / Pkg
M2-6001.001	Instrument Case, ORTHOGNATHICS	240 x 240 mm	1
M2-6001.003*	Instrument Tray, ORTHOGNATHICS, 3, Stryker	240 x 240 mm	1
M2-6001.005*	Instrument Tray, ORTHOGNATHICS, 3, Dental	240 x 240 mm	1
M2-6001.006	Instrument Tray, ORTHOGNATHICS, 2	240 x 240 mm	1
M2-6001.007	Instrument Tray, ORTHOGNATHICS, 1	240 x 240 mm	1
M-6727	Lid f. Implant and Instr.Case 240 x 240 mm	240 x 240 mm	1

Additional configurations available on request.

* Choose between Stryker or Dental Instrument Tray based on drill coupling

R_MANDIBLE2-07010001_v2 / 2023-01, Medartis AG, Switzerland. All technical data subject to alteration.

MANUFACTURER & HEADQUARTERS

Medartis AG | Hochbergerstrasse 60E | 4057 Basel / Switzerland
P +41 61 633 34 34 | F +41 61 633 34 00 | www.medartis.com

SUBSIDIARIES

Australia | Austria | Brazil | France | Germany | Japan | Mexico | New Zealand | Poland | Spain | UK | USA

For detailed information regarding our subsidiaries and distributors, please visit www.medartis.com



Disclaimer: This information is intended to demonstrate the Medartis portfolio of medical devices. A surgeon must always rely on her or his own professional clinical judgement when deciding whether to use a particular product when treating a particular patient. Medartis is not giving any medical advice. The devices may not be available in all countries due to registration and/or medical practices. For further questions, please contact your Medartis representative (www.medartis.com). This information contains products with CE and/or UKCA marking. All pictures shown are for illustration purposes only and may not be an exact representation of the product. For US only: Federal law restricts this device to sale by or on the order of a physician.