

medartis

PRECISION IN FIXATION

SURGICAL TECHNIQUE

MODUS 2 Midface



MODUS

Contents

3	Introduction
3	Product Materials
3	Indications
3	Contraindications
3	Color Coding
3	Possible Combination of Plates and Screws
3	Symbols
4	System Overview
8	Special Plates
9	Treatment Concept
10	Instrument Application
10	General Instrument Application
10	Picking up the Plates
10	Cutting the Plates
11	Bending the Plates
14	Drilling
15	Drilling with Drill Guide
16	Assigning the Screw Length
17	Screw Pick-Up
19	Specific Instrument Application
19	Cutting the Meshes
20	Use of Orbital Retractors
21	Specific Surgical Technique – Orbital Plating System OPS
21	Categorization of the Orbital Floor Plates
22	Cutting the Plates
23	Follow-Up Care and Explanation
23	Follow-Up Care for MODUS 2 Midface Implants
23	Explanation of MODUS 2 Midface Implants
24	Implants, Instruments and Containers

For further information regarding the MODUS product line, visit www.medartis.com

Introduction

Product Materials

Product	Material
Plates	Pure titanium
Screws	Titanium alloy
Instruments	Stainless steel, PEEK, aluminum, Nitinol, silicone or titanium
Containers	Stainless steel, aluminum, PEEK, polyphenylsulfone, polyurethane, silicone

Indications

MODUS 2 Midface is indicated for midfacial trauma repair, fixation of maxillary osteotomies and reconstructive procedures in the midface.

Contraindications

- Preexisting or suspected infection at or near the implantation site
- Known allergies and/or hypersensitivity to implant materials
- Inferior or insufficient bone quality to securely anchor the implant
- Patients who are incapacitated and/or uncooperative during the treatment phase
- Blocking of growth plates with plates and screws

Color Coding

Screw Diameter	Color Code
1.2	Red
1.5	Green
1.8	Yellow

Plates and Screws	
Implant plates gold	Rigid fixation plates
Implant plates blue	Semi-rigid fixation plates*
Implant screws gold	Cortical screws (fixation)
Implant screws green	SpeedTip screws (self-drilling)

Possible Combination of Plates and Screws

Plates and screws can be combined as follows:

Plates	Screws
Midface Fixation Plates	1.2/1.5/1.8 Cortical Screws, HexaDrive 4
	1.5 SpeedTip Screws, HexaDrive 4

Symbols

 HexaDrive

















 SpeedTip



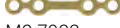

* Semi-rigid is easier to form than rigid materials with the same plate geometry.



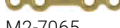



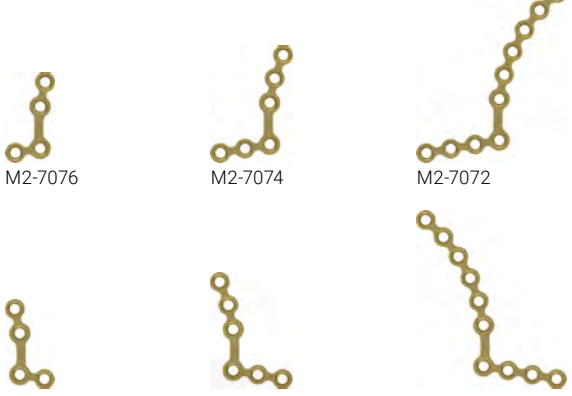

System Overview

The implant plates of MODUS 2 Midface are available in the following designs and, with their range of plate thicknesses, cover all midface anatomical regions:





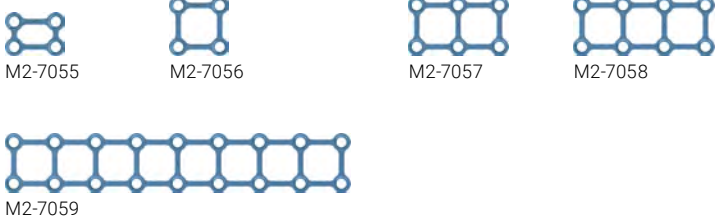
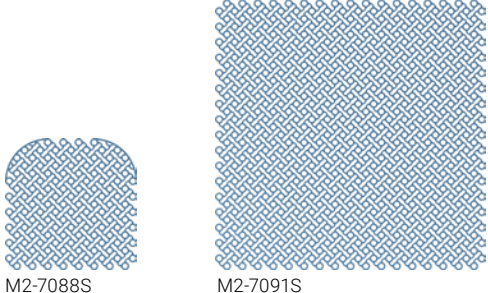
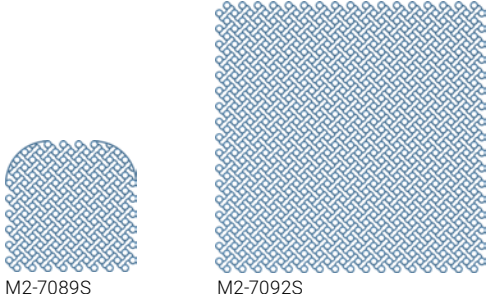
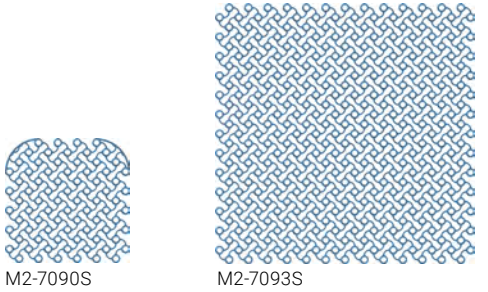

Description	Examples	Plate Thickness	Rigidity
Straight Plates	 <p>M2-7000</p>  <p>M2-7001</p>  <p>M2-7002</p>  <p>M2-7003</p>  <p>M2-7004</p>  <p>M2-7005</p>	t = 0.5 mm	Rigid
	 <p>M2-7027</p>  <p>M2-7028</p>  <p>M2-7029</p>  <p>M2-7030</p>  <p>M2-7031</p>  <p>M2-7032</p>	t = 0.6 mm	Rigid
	 <p>M2-7060</p>  <p>M2-7061</p>  <p>M2-7062</p>  <p>M2-7063</p>  <p>M2-7064</p>  <p>M2-7065</p>	t = 1.0 mm	Rigid

Description	Examples	Plate Thickness	Rigidity
L, T and Y Plates	 <p>M2-7008 M2-7009 M2-7013 M2-7015</p>	t = 0.5 mm	Rigid
	 <p>M2-7035 M2-7036 M2-7045 M2-7048</p>	t = 0.6 mm	Rigid
	 <p>M2-7068 M2-7069 M2-7079 M2-7081</p>	t = 1.0 mm	Rigid
Z Plates	 <p>M2-7043 M2-7041 M2-7039</p> <p>M2-7044 M2-7042 M2-7040</p>	t = 0.6 mm	Rigid
	 <p>M2-7076 M2-7074 M2-7072</p> <p>M2-7077 M2-7075 M2-7073</p>	t = 1.0 mm	Rigid

Description	Examples	Plate Thickness	Rigidity
X and H Plates	 <p>M2-7016 M2-7018 M2-7019</p>	t = 0.5 mm	Rigid
	 <p>M2-7049 M2-7051 M2-7052</p>	t = 0.6 mm	Rigid
	 <p>M2-7082 M2-7084 M2-7085</p>	t = 1.0 mm	Rigid
Curved	 <p>M2-7021</p> <p>M2-7020</p>	t = 0.5 mm	Rigid
	 <p>M2-7054</p> <p>M-7053</p>	t = 0.6 mm	Rigid
	 <p>M2-7087</p> <p>M2-7086</p>	t = 1.0 mm	Rigid

Description	Examples	Plate Thickness	Rigidity
Grid Plates	 <p>M2-7022 M2-7023 M2-7024 M2-7025</p> <p>M2-7026</p>	t = 0.5 mm	Rigid
	 <p>M2-7055 M2-7056 M2-7057 M2-7058</p> <p>M2-7059</p>	t = 0.7 mm	Semi-rigid
Mesh	 <p>M2-7088S M2-7091S</p>	t = 0.25 mm	Semi-rigid
	 <p>M2-7089S M2-7092S</p>	t = 0.4 mm	Semi-rigid
	 <p>M2-7090S M2-7093S</p>	t = 0.6 mm	Semi-rigid

































Special Plates

Description	Categories ¹	Examples	Plate Thickness	Rigidity
Orbital Plating System OPS	Category I Isolated defects of the orbital floor or medial wall, 1–2 cm ² , which do not exceed the anterior two thirds in the anterior-posterior projection.	 M2-7440  M2-7442	t = 0.35 mm	Semi-rigid
	Category II Defects of the orbital floor and/or medial wall > 2 cm ² , which do not exceed the anterior two thirds in the anterior-posterior projection. A bony structure at the medial ledge of the infraorbital fissure is preserved.	 M2-7440  M2-7442  M2-7444  M2-7446	t = 0.35 / 0.4 mm	Semi-rigid
	Category III Defects of the orbital floor and/or medial wall > 2 cm ² , which do not exceed the anterior two thirds in the anterior-posterior projection. Absence of a bony ledge at the medial aspect of the infraorbital fissure.	M2-7444 M2-7446	t = 0.4 mm	Semi-rigid
	Category IV Defects of the whole orbital floor and medial wall extending to the posterior third and without bony ledge at the medial aspect of the infraorbital fissure.	M2-7444 M2-7446	t = 0.4 mm	Semi-rigid

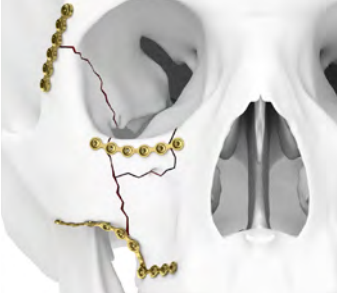
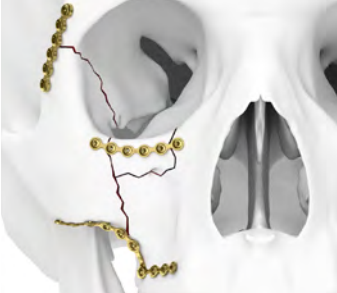
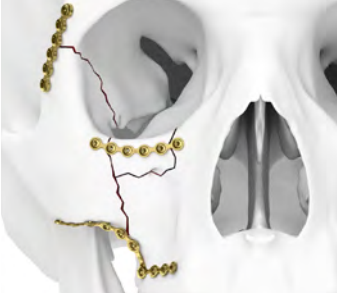
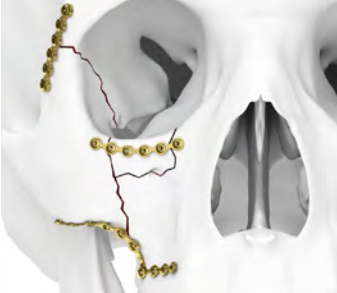
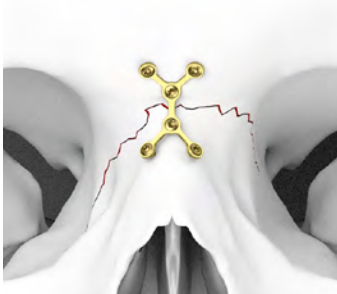
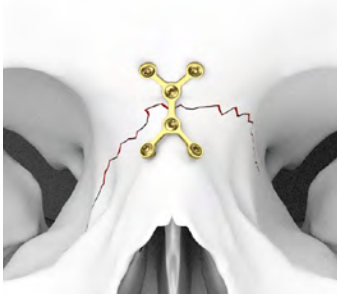
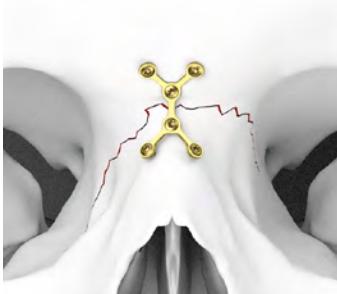
¹ Jaquiéry, C., Aeppli, C., Cornelius, P., Palmowsky, A., Kunz, C., Hammer, B. Reconstruction of orbital wall defects: critical review of 72 patients Int J Oral Maxillofac Surg. 2007 Mar; 36(3): 193–9.

Treatment Concept

The following is an overview of typical clinical findings that can be treated with the implants of MODUS 2 Midface.

<p>Anatomical Regions</p>											
<p>Plate Examples</p>	 <p>M2-7014</p>	 <p>M2-7047</p>	 <p>M2-7081</p>				 <p>M2-7054</p>	 <p>M2-7062</p>			
 <p>M2-7016</p>	 <p>M2-7049</p>	 <p>M2-7083</p>				 <p>M2-7024</p>	 <p>M2-7058</p>				
 <p>M2-7018</p>	 <p>M2-7051</p>	 <p>M2-7084</p>									
											

The information provided above is a recommendation only. The operating surgeon is solely responsible for choosing the appropriate implant for the specific case.

Instrument Application

General Instrument Application

Picking up the Plates

The use of the angled plate and screw holding forceps (M-2009 or M-2019) is recommended to remove the plates. Hold the plate with the forceps as close as possible to the plate-holding pin with spring and pull out of the holder from above.

Cutting the Plates

The “cut before bending” principle applies.

There are two different types of cutting pliers which can be used to cut MODUS 2 Midface plates:

Type 1: Plate cutting pliers (M2-2114) to $t \leq 1.3$ mm

Type 2: Plate cutting pliers (A-2046) 1.2–2.8 to $t \leq 1.6$ mm

Warning

Wrong cutting of the plate may result in sharp edges and lead to injuries of the surrounding tissue.

Type 1

All MODUS 2 Midface plates can be cut with the M2-2114 plate cutting pliers. Ensure that there are no remaining plate segments in the cutting pliers (visual check). Hold the implantable plate segment with your hand during and after cutting.

Insert the plate from the left into the open cutting pliers. The hole countersinks must face upward.

Notice

To facilitate the insertion of the plate, support the cutting pliers gently with your middle finger.

You can visually check the desired cutting line through the cutting window in the head of the pliers (see figure). Always leave enough material on the rest of the plate to keep the adjacent hole intact. The cutting process rounds off the cut edge. The visible part of the plate corresponds to the desired plate length.

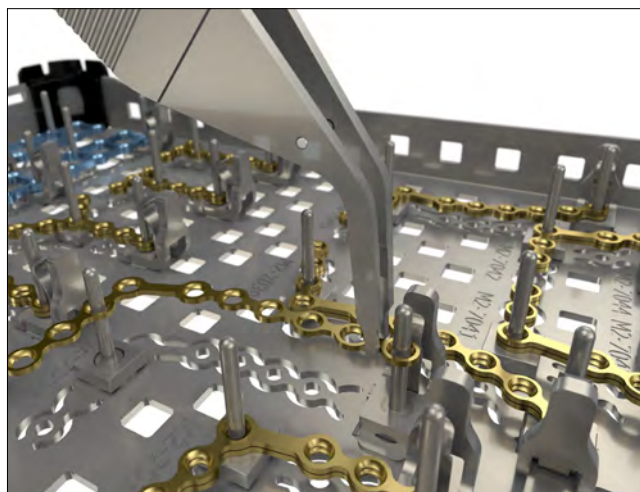

Type 2

All MODUS 2 Midface plates can be cut with the A-2046 plate cutting pliers. Ensure that there are no remaining plate segments in the cutting pliers (visual check). Insert the plate from the front into the open cutting pliers. The hole counter-sinks must face upward.

To facilitate the insertion of the plate, support the cutting pliers gently with your middle finger.

You can visually check the desired cutting line through the cutting window in the head of the pliers (see figure). Always leave enough material on the rest of the plate to keep the adjacent hole intact. The cutting process rounds off the cut edge. The visible part of the plate corresponds to the desired plate length.

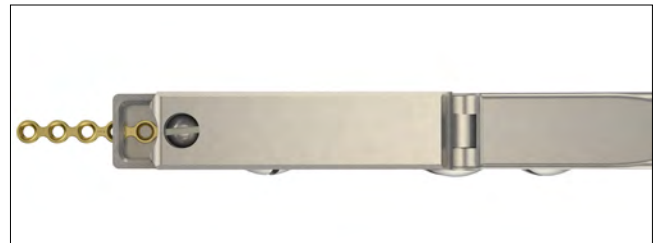
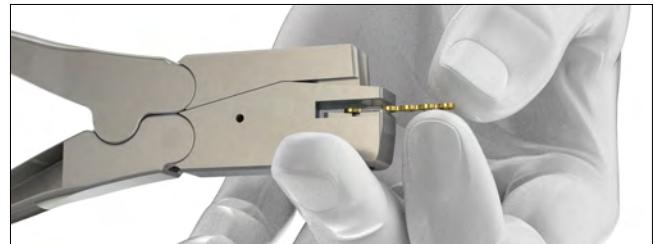

Caution

When cutting with both types of pliers, keep your hand loosely around the pliers to ensure that no parts fly off.



Bending the Plates

Warning

Wrong bending of the plate may lead to impaired functionality and postoperative construct failure.

If necessary, the MODUS 2 Midface plates can be bent. There are various options available for this:

Instrument	Functions
1.2–1.8 Plate bending pliers (M2-2002)	- Flat plier function - Bending outside the plane - Bending within the plane (for plates > 0.5 mm)
1.2–1.8 Plate bending pliers with pin (M2-2012)	- Simultaneous bending in multiple planes (3D)
Plate bending pliers flat nose (M2-2000)	- Simultaneous bending in multiple planes (3D)

The plate bending pliers with pin are always used in pairs.

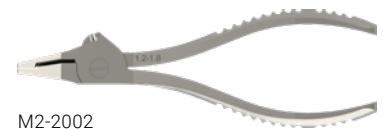

M2-2002
1.2–1.8 Plate Bending Pliers



M2-2012
1.2–1.8 Plate Bending Pliers with Pin



M2-2000
Plate Bending Pliers, Flat Nose

Flat plier function

1.2–1.8 Plate bending pliers (M2-2002)

The frontmost part of the jaws of the plate bending pliers can be used as flat nose pliers with a holding function.

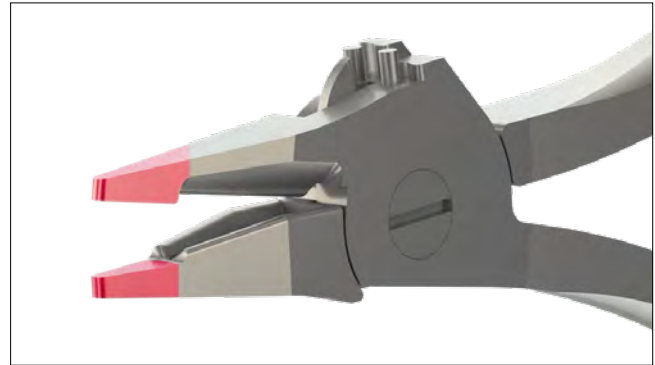

Bending outside the plane

1.2–1.8 Plate bending pliers (M2-2002)

Bars can be bent with the 90° bending function between the jaws of the plate bending pliers.

Position the plate in the pliers between the jaws. The slot permits the plate to be viewed.

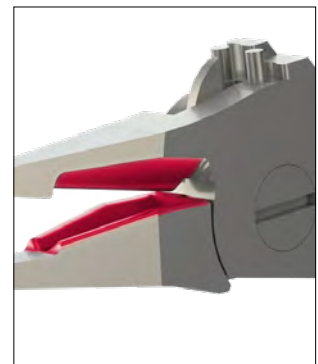

Bending within the plane/Aderer function

1.2–1.8 Plate bending pliers (M2-2002)

A three-jaw plier function known as the “Aderer function” is integrated into the plate bending pliers so that the plates bend within the plane.

Place the plate onto the pins. Closing the pliers will bend the plate within the plane.

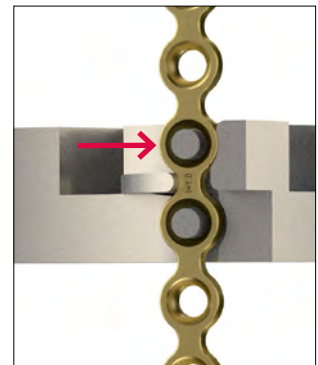

Simultaneous bending in multiple planes/3D Bending

1.2–1.8 Plate bending pliers (M2-2012)

Hold the plate bending pliers with pin (M2-2012) so that the pin enters the plate hole from above (with the “UP” marking on the plate bending pliers pointing upward). The purpose of this process is to protect the plate hole from deformities.

Regularly check the curvature of the plate to prevent overbending and thereby excess strain on the plate.



While bending, the plate must always be held at two adjacent holes to prevent contour deformation of the intermediate plate hole.



Warning

Do not bend plates without a bar by more than 30°. Bending the plate further may deform the plate holes and may cause the plate to break postoperatively.

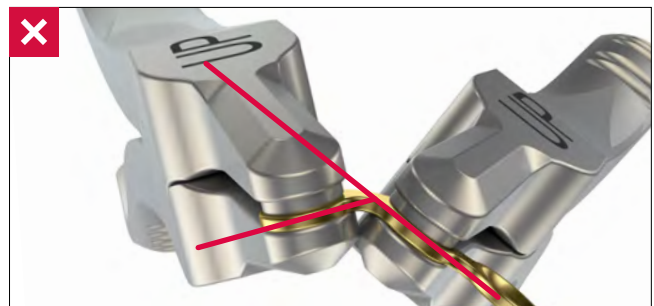
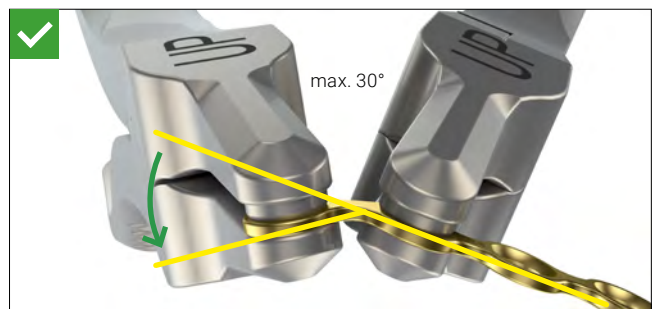

Warning

Repeatedly bending the plate in opposite directions may cause the plate to break postoperatively. Always use the provided plate bending pliers to avoid damaging the plate holes. Damaged plate holes prevent correct and secure seating of the screw in the plate and increase the risk of system failure.



Drilling

Color-coded twist drills are available for each MODUS 2 screw diameter. All drills are color coded with a ring system.

Screw Diameter	Color Code
1.2	Red
1.5	Green
1.8	Yellow

There are two different types of twist drill:

Core hole drills are marked with one colored ring and gliding hole drills (for lag screw technique) are marked with two colored rings.

Core Hole Drills (one colored ring)

Drills for screws \varnothing 1.2 (drill \varnothing 1.0)

Dental	Stryker	
M2-3012	M2-3022	5 mm
M2-3032	M2-3042	7 mm
M2-3052	M2-3062	25 mm



Drills for screws \varnothing 1.5 (drill \varnothing 1.2)

Dental	Stryker	
M2-3122	M2-3132	5 mm
M2-3142	M2-3152	7 mm
M2-3162	M2-3172	25 mm



Drills for screws \varnothing 1.8 (drill \varnothing 1.5)

Dental	Stryker	
M2-3212	M2-3222	5 mm
M2-3232	M2-3242	7 mm
M2-3252	M2-3262	25 mm



Gliding Hole Drills (two colored rings)

Drills for screws \varnothing 1.2 (drill \varnothing 1.2)

Dental	Stryker	
M2-3072	M2-3082	25 mm



Drills for screws \varnothing 1.5 (drill \varnothing 1.5)

Dental	Stryker	
M2-3182	M2-3192	25 mm



Drills for screws \varnothing 1.8 (drill \varnothing 1.8)

Dental	Stryker	
M2-3272	M2-3282	25 mm



Drilling with Drill Guide

Drilling with a drill guide protects surrounding tissue from direct contact with the drill. The 1.2–1.8 drill guide (M2-2202) can be used for all MODUS 2 Midface plates.

The end of the drill guide marked with \varnothing 1.0–1.2 is used with drills with a maximum diameter of 1.2 mm. The opposite end is designed for use with twist drills from a diameter of 1.5 mm.

Notice

To drill a gliding hole for the screw diameter 1.5 mm, use the end of the drill guide marked with \varnothing 1.0–1.8.

After positioning the plate, insert the drill guide and the twist drill into the screw hole. The drill is guided by the shaft of the drill and not the drill flute.

Drills for use in combination with the drill guide:

Core Hole Drills (one colored ring)

Drills for screws \varnothing 1.2 (drill \varnothing 1.0)

Dental	Stryker	
M2-3382	M2-3392	25 mm

Drills for screws \varnothing 1.5 (drill \varnothing 1.2)

Dental	Stryker	
M2-3402	M2-3412	25 mm

Drills for screws \varnothing 1.8 (drill \varnothing 1.5)

Dental	Stryker	
M2-3422	M2-3452	25 mm

Gliding Hole Drills (two colored rings)

Drills for screws \varnothing 1.2 (drill \varnothing 1.2)

Dental	Stryker	
M2-3322	M2-3332	25 mm

Drills for screws \varnothing 1.5 (drill \varnothing 1.5)

Dental	Stryker	
M2-3342	M2-3352	25 mm

Drills for screws \varnothing 1.8 (drill \varnothing 1.8)

Dental	Stryker	
M2-3362	M2-3372	25 mm



M2-2202
1.2-1.8 Drill Guide



M2-3382



M2-3402



M2-3422



M2-3322



M2-3342



M2-3362

Assigning the Screw Length

The depth gauge (M2-2250) is used to determine the ideal screw length for use in bicortical or monocortical screw fixation.

Retract the slider of the depth gauge.



M2-2250
1.2–2.3 Depth Gauge

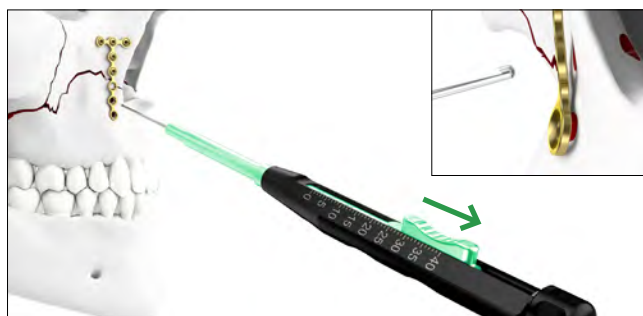

The caliper of the depth gauge has a hooked tip that is either inserted to the bottom of the hole or is used to catch the far cortex of the bone. When using the depth gauge, the caliper stays static and only the slider is adjusted.



To assign the screw length, place the distal end of the slider onto the implant plate.

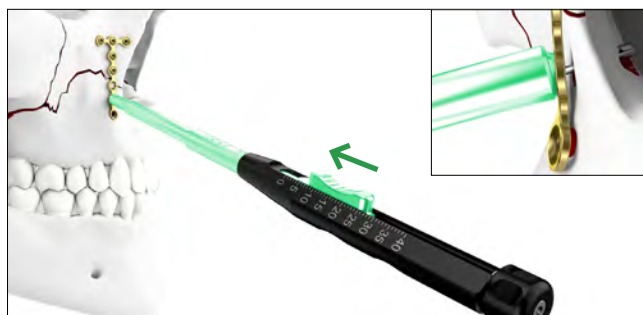

The ideal screw length for the assigned drill hole can be read on the scale of the depth gauge.

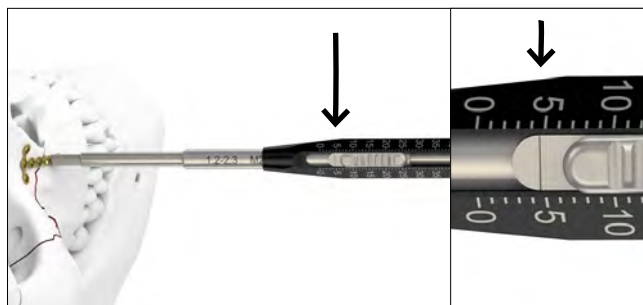

Screw Pick-Up

The screwdriver handles (M2-2001 and M2-2003) are compatible with the screwdriver blade (M2-2004). The screwdriver blade features the patented self-holding technology HexaDrive.



M2-2003
Type 1 Screwdriver Handle



M2-2001
Type 2 Screwdriver Handle



M2-2004
Screwdriver Blade, HD4, 80 mm

Notice

All screws up to 7 mm in length are secured with a securing element. To remove these screws, turn the securing element to the right with the screwdriver. This releases the screws.



To remove the screws from the implant container, insert the appropriately color-coded screwdriver blade perpendicularly into the screw head of the desired screw and pick up the screw with axial pressure.

Notice

The screw will not hold without axial pressure.

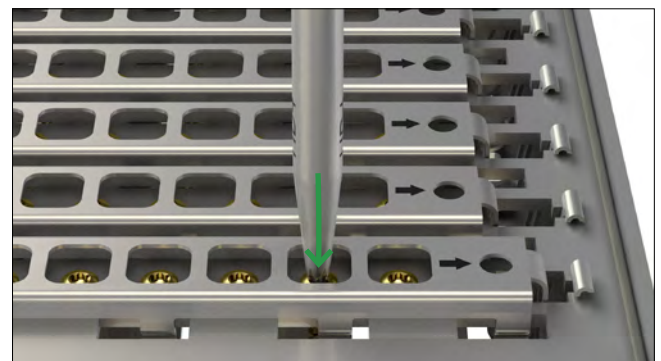

Caution

Vertically extract the screw from the compartment. Picking up the screw repeatedly may lead to permanent deformation of the self-retaining area of the HexaDrive inside the screw head. Therefore, the screw may no longer be able to be picked up correctly. In this case, a new screw has to be used.

Notice

The screw length is checked with the measuring module and read at the end of the screw head.

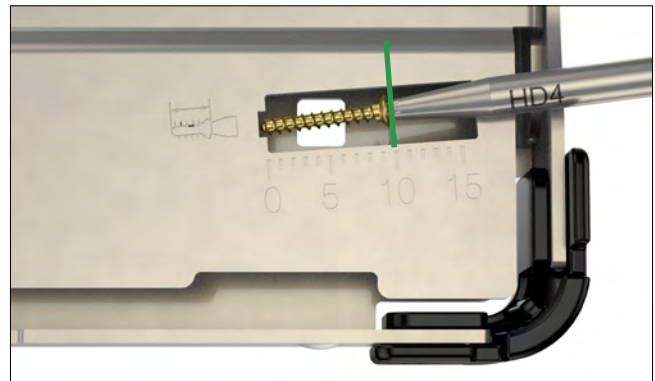

Check the correct screw diameter:

The screw can be inserted into the hole of the appropriate screw diameter. The screw will not fit in the hole for the next screw size down.

Notice

Check SpeedTip screws in the hole \varnothing 1.8.

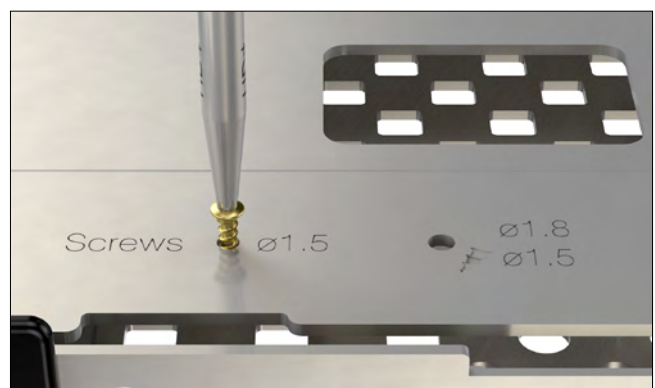

Notice

After removing screws up to a length of 7 mm it is important to ensure that the securing elements are closed again to prevent the screws from dropping out. To do this, lightly press down on the outer left of the securing element and it will close of its own accord.



Screws secured with a securing element cannot be directly removed with the 90° screwdriver.

These screws must be removed with the screwdriver blade and stored temporarily in the screw measuring module. From here the screw can be picked up with the 90° screwdriver.



Specific Instrument Application

Cutting the Meshes

There are two different types of cutting pliers which can be used to cut MODUS 2 Midface Meshes:

Type 1: Mesh cutting pliers (M2-2870), curved, left

Type 2: Mesh cutting pliers (M2-2115)

Warning

Wrong cutting of the plate may result in sharp edges and lead to injuries of the surrounding tissue.

Type 1

Always leave enough material on the lug hole to keep the adjacent lug hole intact. Also ensure that there are no sharp cut edges.

Type 2

You can visually check the desired cutting line through the cutting window in the head of the pliers (see figure). The cutting process rounds off the cut edge. The visible part of the mesh corresponds to the desired size.

Caution

When cutting with both types of pliers, keep your hand loosely around the pliers to ensure that no parts fly off.



M2-2870
Mesh Cutting Pliers, Curved, Left

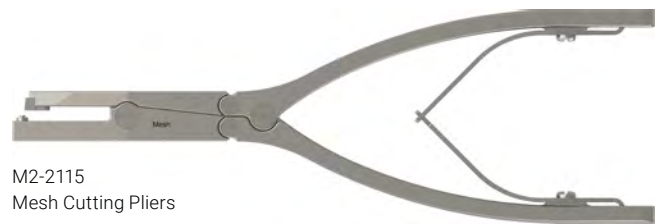

M2-2115
Mesh Cutting Pliers

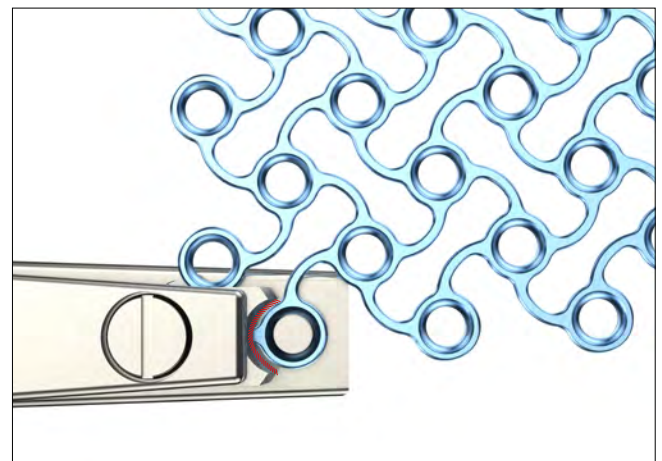
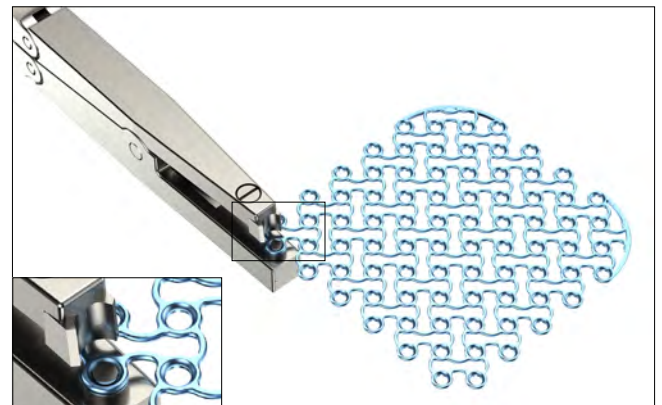

Use of Orbital Retractors

Three orbital retractors (M2-2121, M2-2122, M2-2123) are available in the MODUS 2 Midface OPS to protect the orbital soft tissue and to determine the size of the defect.



M2-2121
Orbital Retractor, Right



M2-2122
Orbital Retractor, Left



M2-2123
Orbital Retractor

The orbital retractors are available in left, right and neutral designs, and all feature a small and a large retractor end. The shape and size of the retractor ends are tailored to the design of the MODUS 2 Midface orbital floor plates. A scale helps to estimate the orbital dimensions.

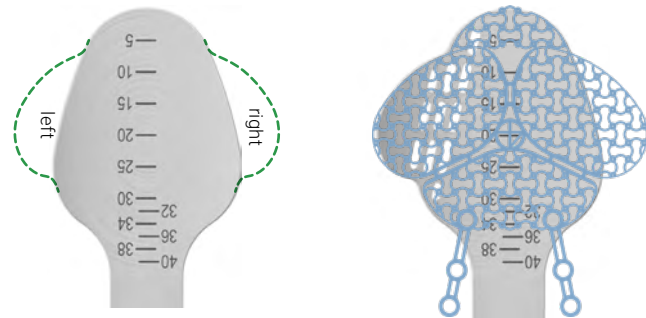









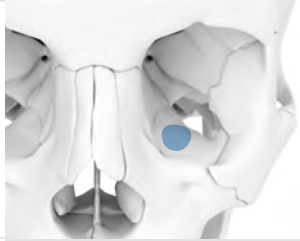

For better intraoperative handling and insertion into the orbital aperture, the malleable retractors can best be shaped on the medial orbital wall. The retractors can be used both to hold back the soft tissue and to determine the fracture size.

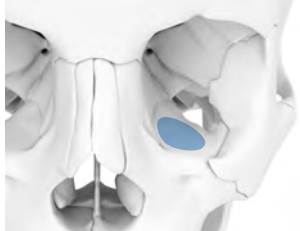

Specific Surgical Technique – Orbital Plating System OPS

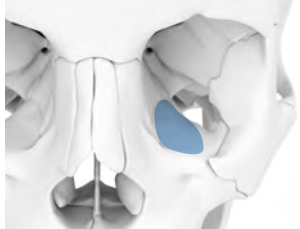
Categorization of the Orbital Floor Plates¹

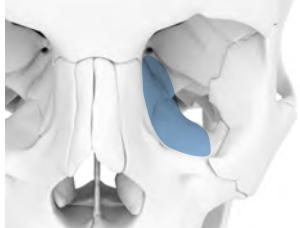
 <p>M2-7440</p>	 <p>M2-7442</p>				<p>Category I Isolated defects of the orbital floor or medial wall, 1–2 cm², which do not exceed the anterior two thirds in the anterior-posterior projection.</p>
 <p>M2-7440</p>	 <p>M2-7442</p>	 <p>M2-7444</p>	 <p>M2-7446</p>		<p>Category II Defects of the orbital floor and/or medial wall > 2 cm², which do not exceed the anterior two thirds in the anterior-posterior projection. A bony structure at the medial ledge of the infraorbital fissure is preserved.</p>
		 <p>M2-7444</p>	 <p>M2-7446</p>		<p>Category III Defects of the orbital floor and/or medial wall > 2 cm², which do not exceed the anterior two thirds in the anterior-posterior projection.. Absence of a bony ledge at the medial aspect of the infraorbital fissure.</p>
		 <p>M2-7444</p>	 <p>M2-7446</p>		<p>Category IV Defects of the whole orbital floor and medial wall extending to the posterior third and without bony ledge at the medial aspect of the infraorbital fissure.</p>

¹ Jaquiéry, C., Aeppli, C., Cornelius, P., Palmowsky, A., Kunz, C., Hammer, B. Reconstruction of orbital wall defects: critical review of 72 patients Int J Oral Maxillofac Surg. 2007 Mar; 36(3): 193–9.

Cutting the Plates

The orbital floor plates can be cut in various ways along the bars, depending on the type of fracture. Possible cutting patterns are illustrated below:

A:

Depending on the specific approach, fixation bars can be removed (cut either one hole off or the complete bar).

B:

For a small anterior orbital floor fracture, in many cases the first mesh segment is sufficient (cutting line from B to B).

C:

To reduce the risk of the infraorbital nerve being damaged, the front part of the orbital plate can be cut (cutting line from C to C).

D:

If only one orbital wall is fractured, one wing of the mesh can be cut off along the bar.

Combination of B and C

For smaller defects, the anterior mesh segment and a lateral segment can be used (cutting line from the starting point B diagonally to the endpoint C).

In addition to this, and depending on the approach, the length of the fixation bars of the plate can be trimmed. For the transconjunctival approach, cutting of the first holes within the fixation bars is recommended.

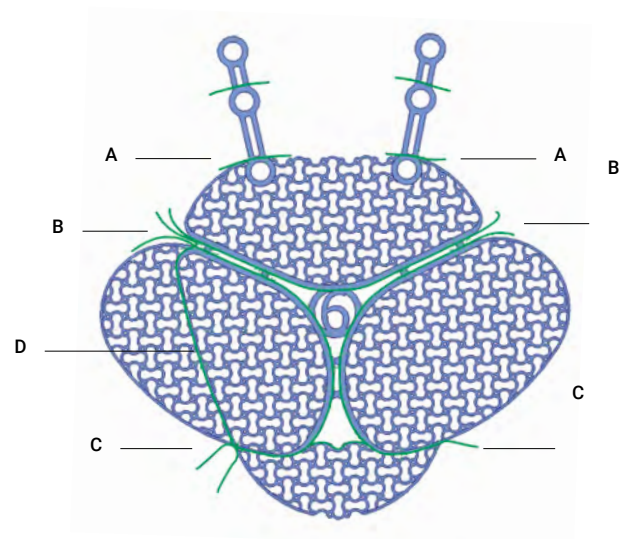
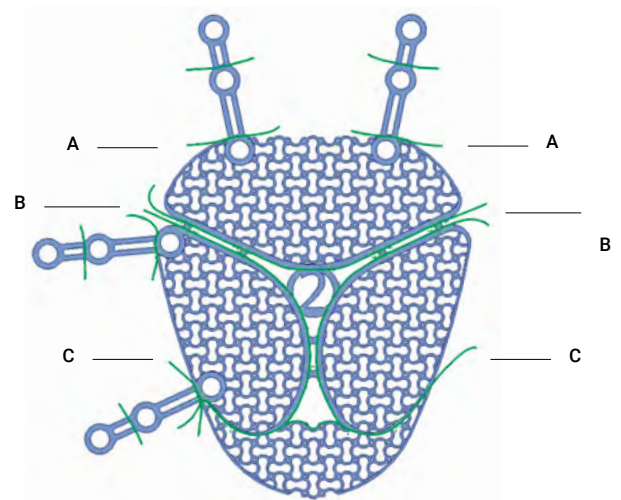

Follow-Up Care and Explantation

Follow-Up Care for MODUS 2 Midface Implants

Taking into account the individual osteotomy and fracture conditions and patient compliance, it is important to ensure adequate postoperative relief of the osteosynthesis in terms of adaptation or mobilization stability (e.g. splinting and/or immobilization). Postoperatively, the fixation achieved with the implants must be treated with care until the bone has fully healed. Patients must closely observe follow-up instructions given by their physicians to avoid detrimental strain on the implants. Premature loading can increase the risk of loosening, migration or breakage of the implant.

Explantation of MODUS 2 Midface Implants

Use the appropriate screwdrivers to remove the screws to explant MODUS 2 Midface plates.

Caution

Only MODUS 2 instruments are recommended for the explantation of MODUS 2 implants. When removing the screws, ensure that any bone ingrowth in the screw head has been removed, that the screwdriver/screw head connection is aligned in axial direction, and that a sufficient axial force is used between blade and screw.

Implants, Instruments and Containers

Orbital Floor Plates

Material: Titanium (ASTM F67), semi-rigid
Plate thickness: 0.35 mm / 0.4 mm

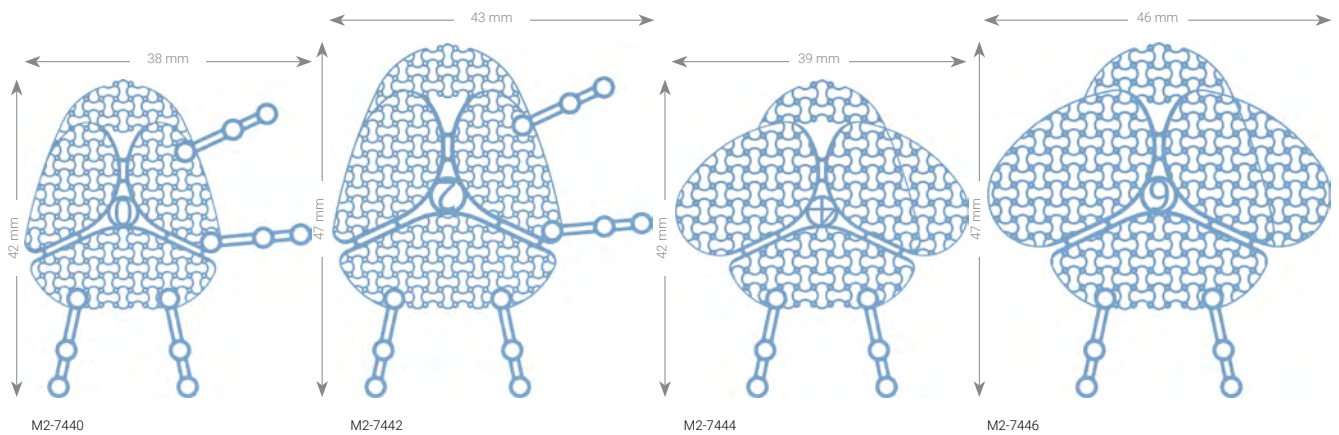

Art. No.	STERILE	Description	Plate Thickness	Holes	Pieces / Pkg
M2-7440	M2-7440S	1 – 2 small	0.35 mm	12	1
M2-7442	M2-7442S	1 – 2 large	0.35 mm	12	1
M2-7444	M2-7444S	2 – 4 small	0.4 mm	6	1
M2-7446	M2-7446S	2 – 4 large	0.4 mm	6	1

Scale 1:1

Mesh

Material: Titanium (ASTM F67), semi-rigid
Plate thickness: 0.25 mm / 0.4 mm / 0.6 mm

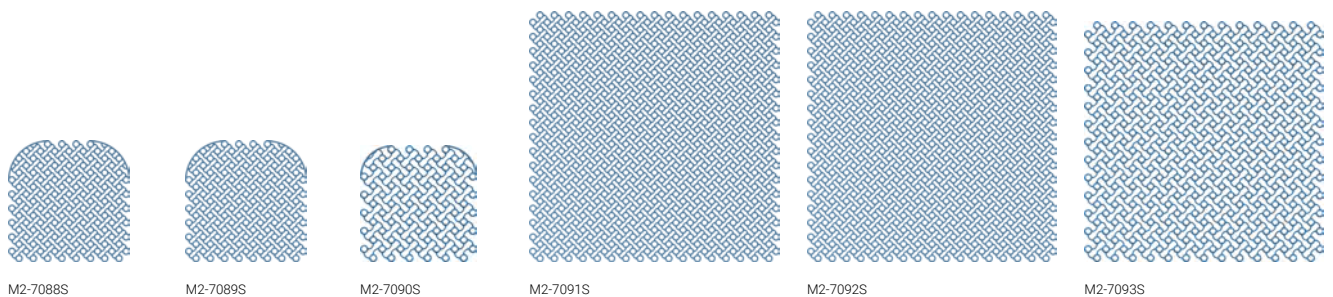

Art. No.	STERILE	Description	Size	Plate Thickness	Pieces / Pkg
M2-7088S		mesh 1	50 × 50 mm	0.25 mm	1
M2-7089S		mesh 2	50 × 50 mm	0.4 mm	1
M2-7090S		mesh 3	50 × 50 mm	0.6 mm	1
M2-7091S		mesh 1	100 × 100 mm	0.25 mm	1
M2-7092S		mesh 2	100 × 100 mm	0.4 mm	1
M2-7093S		mesh 3	100 × 100 mm	0.6 mm	1

MIDFACE Plates t = 0.5 mm

Straight Plates

Material: Titanium (ASTM F67)
Plate thickness: 0.5 mm

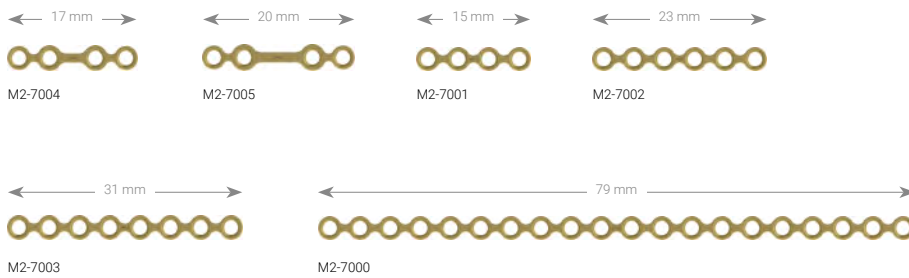

Art. No.	STERILE	Description	Bar	Holes	Pieces / Pkg
M2-7000	M2-7000S	straight		20	1
M2-7001	M2-7001S	straight		4	1
M2-7002	M2-7002S	straight		6	1
M2-7003	M2-7003S	straight		8	1
M2-7004	M2-7004S	straight	6 mm	4	1
M2-7005	M2-7005S	straight	9 mm	4	1

L Plates

Material: Titanium (ASTM F67)
Plate thickness: 0.5 mm

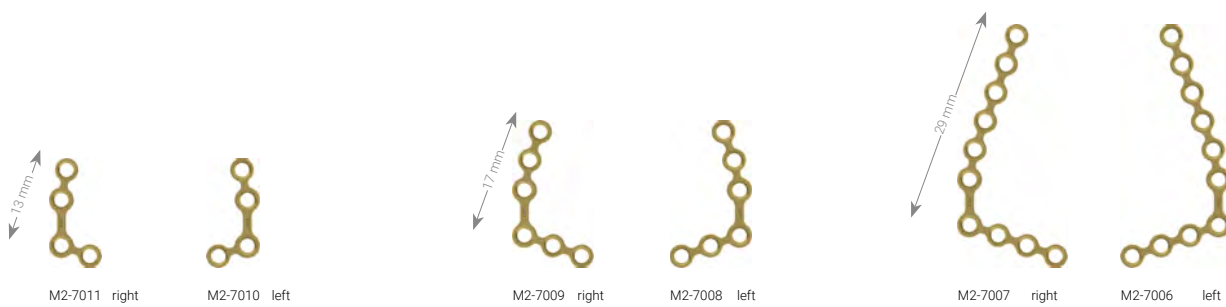

Art. No.	STERILE	Description	Bar	Holes	Pieces / Pkg
M2-7006	M2-7006S	L left 100°	6 mm	10 (4/6)	1
M2-7007	M2-7007S	L right 100°	6 mm	10 (4/6)	1
M2-7008	M2-7008S	L left 100°	6 mm	6 (3/3)	1
M2-7009	M2-7009S	L right 100°	6 mm	6 (3/3)	1
M2-7010	M2-7010S	L left 100°	6 mm	4 (2/2)	1
M2-7011	M2-7011S	L right 100°	6 mm	4 (2/2)	1

T Plates

Material: Titanium (ASTM F67)
Plate thickness: 0.5 mm

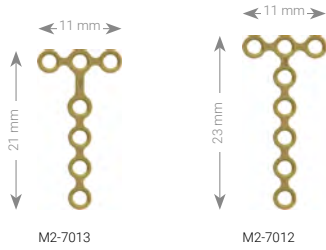

Art. No.	STERILE	Description	Bar	Holes	Pieces / Pkg
M2-7012	M2-7012S	T		8 (3/5)	1
M2-7013	M2-7013S	T	6 mm	7 (3/4)	1

Y Plates

Material: Titanium (ASTM F67)
Plate thickness: 0.5 mm

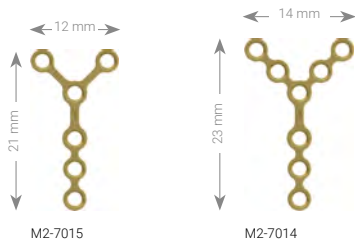

Art. No.	STERILE	Description	Bar	Holes	Pieces / Pkg
M2-7014	M2-7014S	Y	6 mm	8 (5/3)	1
M2-7015	M2-7015S	Y	6 mm	6 (3/3)	1

X Plates

Material: Titanium (ASTM F67)
Plate thickness: 0.5 mm

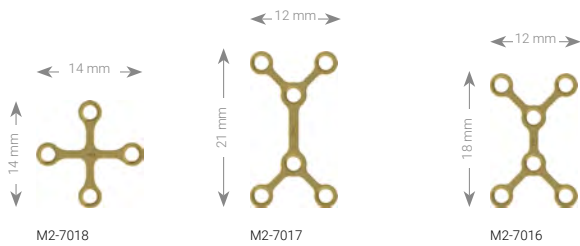

Art. No.	STERILE	Description	Bar	Holes	Pieces / Pkg
M2-7016	M2-7016S	X	6 mm	6	1
M2-7017	M2-7017S	X	9 mm	6	1
M2-7018	M2-7018S	X		4	1

H Plate

Material: Titanium (ASTM F67)
Plate thickness: 0.5 mm

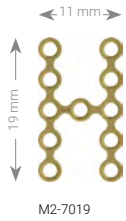

Art. No.	STERILE	Description	Bar	Holes	Pieces / Pkg
M2-7019	M2-7019S	H	4 mm	11	1

Orbital Rim Plates

Material: Titanium (ASTM F67)
Plate thickness: 0.5 mm

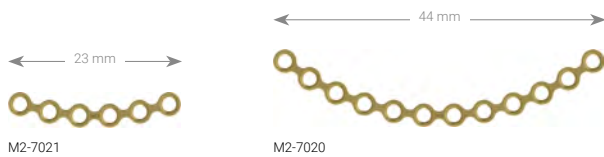

Art. No.	STERILE	Description	Holes	Pieces / Pkg
M2-7020	M2-7020S	curved	12	1
M2-7021	M2-7021S	curved	6	1

Grid Plates

Material: Titanium (ASTM F67)
Plate thickness: 0.5 mm

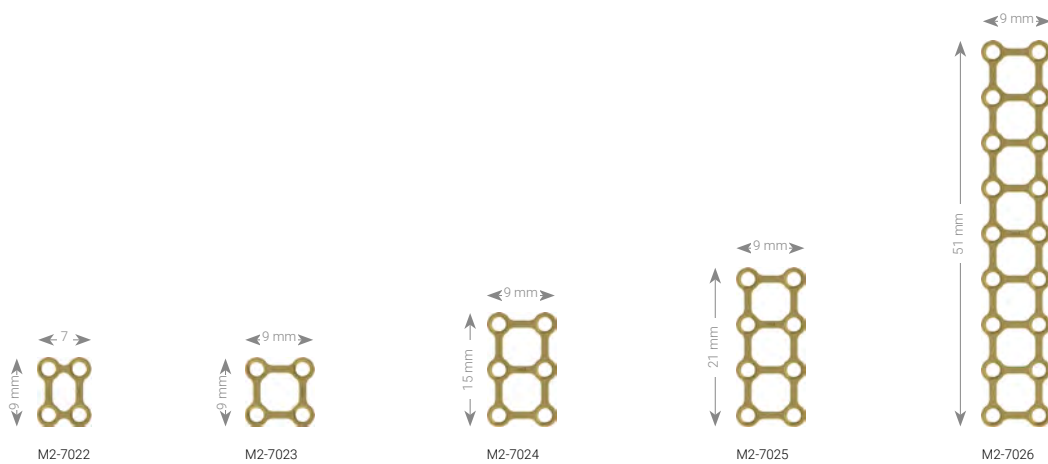

Art. No.	STERILE	Description	Holes	Pieces / Pkg
M2-7022	M2-7022S	H	4 (2x2)	1
M2-7023	M2-7023S	H	4 (2x2)	1
M2-7024	M2-7024S	H	6 (3x2)	1
M2-7025	M2-7025S	H	8 (4x2)	1
M2-7026	M2-7026S	H	18 (9x2)	1

MIDFACE Plates t = 0.6 / 0.7 mm

Straight Plates

Material: Titanium (ASTM F67)
Plate thickness: 0.6 mm

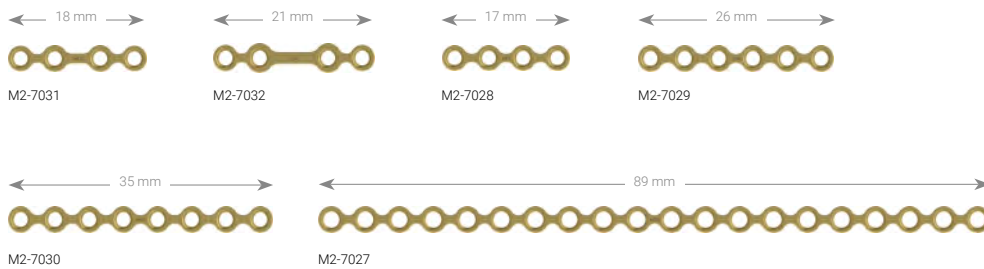

Art. No.	STERILE	Description	Bar	Holes	Pieces / Pkg
M2-7027	M2-7027S	straight		20	1
M2-7028	M2-7028S	straight		4	1
M2-7029	M2-7029S	straight		6	1
M2-7030	M2-7030S	straight		8	1
M2-7031	M2-7031S	straight	6 mm	4	1
M2-7032	M2-7032S	straight	9 mm	4	1

L Plates

Material: Titanium (ASTM F67)
Plate thickness: 0.6 mm

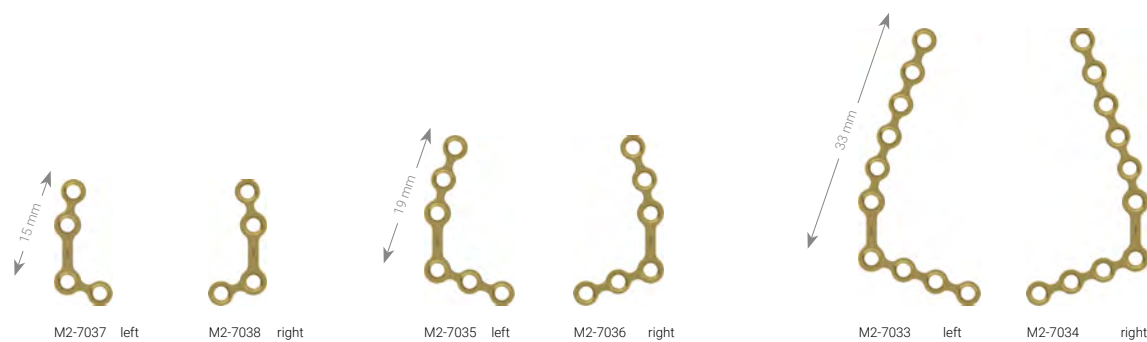

Art. No.	STERILE	Description	Bar	Holes	Pieces / Pkg
M2-7033	M2-7033S	L left 100°	7.5 mm	10 (4/6)	1
M2-7034	M2-7034S	L right 100°	7.5 mm	10 (4/6)	1
M2-7035	M2-7035S	L left 100°	7.5 mm	6 (3/3)	1
M2-7036	M2-7036S	L right 100°	7.5 mm	6 (3/3)	1
M2-7037	M2-7037S	L left 100°	7.5 mm	4 (2/2)	1
M2-7038	M2-7038S	L right 100°	7.5 mm	4 (2/2)	1

T Plates

Material: Titanium (ASTM F67)
Plate thickness: 0.6 mm

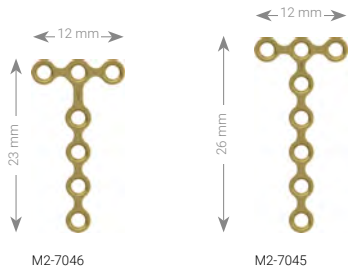

Art. No.	STERILE	Description	Bar	Holes	Pieces / Pkg
M2-7045	M2-7045S	T		8 (3/5)	1
M2-7046	M2-7046S	T	6 mm	7 (3/4)	1

Y Plates

Material: Titanium (ASTM F67)
Plate thickness: 0.6 mm

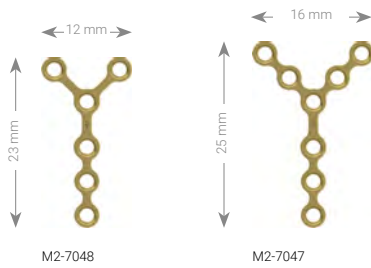

Art. No.	STERILE	Description	Bar	Holes	Pieces / Pkg
M2-7047	M2-7047S	Y	6 mm	8 (5/3)	1
M2-7048	M2-7048S	Y	6 mm	6 (3/3)	1

Z Plates

Material: Titanium (ASTM F67)
Plate thickness: 0.6 mm

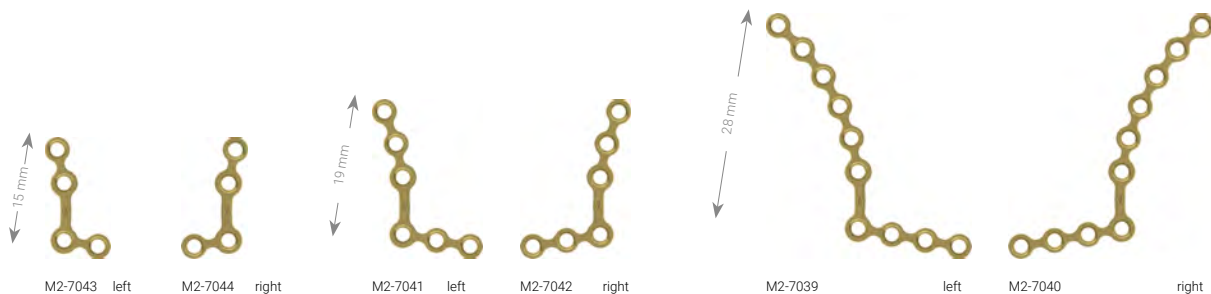

Art. No.	STERILE	Description	Bar	Holes	Pieces / Pkg
M2-7039	M2-7039S	Z left 100°	7.5 mm	10 (4/6)	1
M2-7040	M2-7040S	Z right 100°	7.5 mm	10 (4/6)	1
M2-7041	M2-7041S	Z left 100°	7.5 mm	6 (3/3)	1
M2-7042	M2-7042S	Z right 100°	7.5 mm	6 (3/3)	1
M2-7043	M2-7043S	Z left 100°	7.5 mm	4 (2/2)	1
M2-7044	M2-7044S	Z right 100°	7.5 mm	4 (2/2)	1

X Plates

Material: Titanium (ASTM F67)
Plate thickness: 0.6 mm

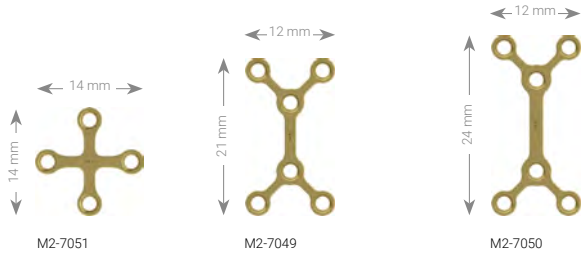

Art. No.	STERILE	Description	Bar	Holes	Pieces / Pkg
M2-7049	M2-7049S	X	9 mm	6	1
M2-7050	M2-7050S	X	12 mm	6	1
M2-7051	M2-7051S	X		4	1

H Plate

Material: Titanium (ASTM F67)
Plate thickness: 0.6 mm

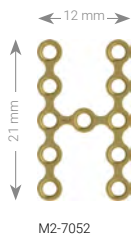

Art. No.	STERILE	Description	Bar	Holes	Pieces / Pkg
M2-7052	M2-7052S	H	4.5 mm	11	1

Orbital Rim Plates

Material: Titanium (ASTM F67)
Plate thickness: 0.6 mm

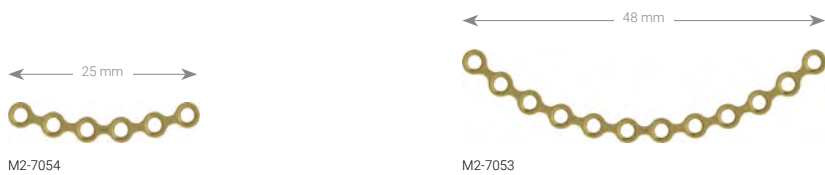

Art. No.	STERILE	Description	Holes	Pieces / Pkg
M2-7053	M2-7053S	curved	12	1
M2-7054	M2-7054S	curved	6	1

Grid Plates

Material: Titanium (ASTM F67)
Plate thickness: 0.7 mm

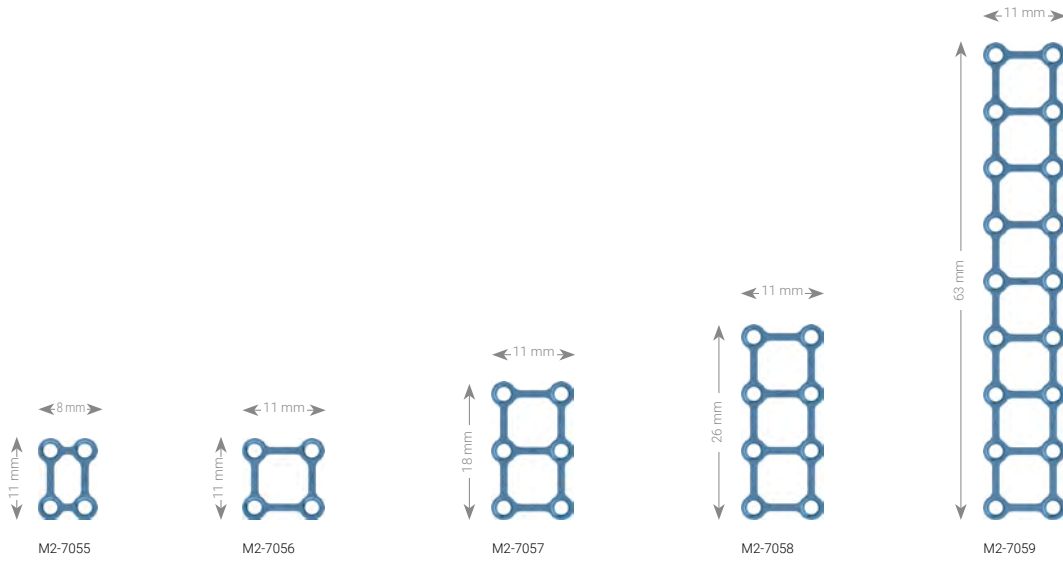

Art. No.	STERILE	Description	Bar	Holes	Pieces / Pkg
M2-7055	M2-7055S	H	4.5 × 7.5 mm	4 (2x2)	1
M2-7056	M2-7056S	H	7.5 × 7.5 mm	4 (2x2)	1
M2-7057	M2-7057S	H	7.5 × 7.5 mm	6 (3x2)	1
M2-7058	M2-7058S	H	7.5 × 7.5 mm	8 (4x2)	1
M2-7059	M2-7059S	H	7.5 × 7.5 mm	18 (9x2)	1

MIDFACE Plates t = 1.0 mm

Straight Plates

Material: Titanium (ASTM F67)
Plate thickness: 1.0 mm

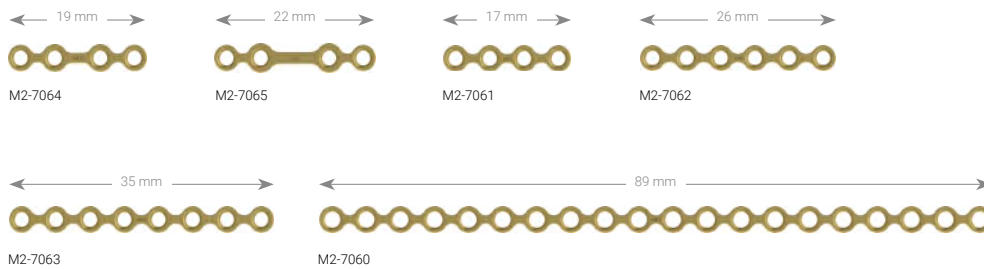

Art. No.	STERILE	Description	Bar	Holes	Pieces / Pkg
M2-7060	M2-7060S	straight		20	1
M2-7061	M2-7061S	straight		4	1
M2-7062	M2-7062S	straight		6	1
M2-7063	M2-7063S	straight		8	1
M2-7064	M2-7064S	straight	6 mm	4	1
M2-7065	M2-7065S	straight	9 mm	4	1

L Plates

Material: Titanium (ASTM F67)
Plate thickness: 1.0 mm

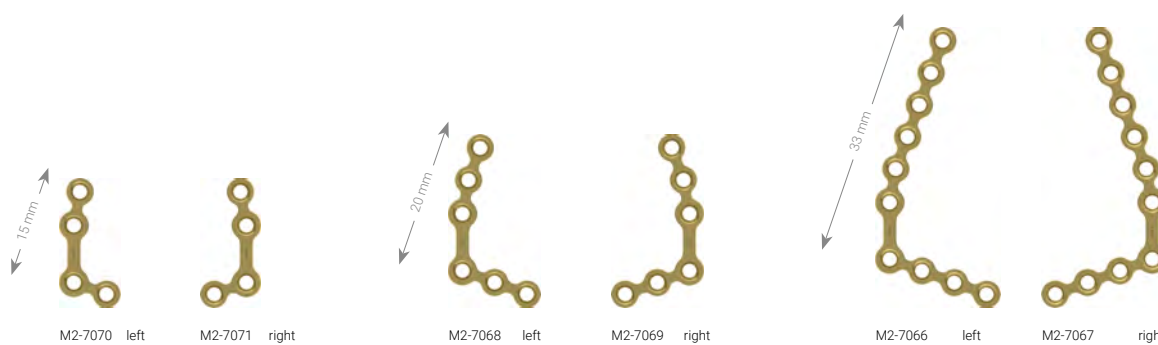

Art. No.	STERILE	Description	Bar	Holes	Pieces / Pkg
M2-7066	M2-7066S	L left 100°	7.5 mm	10 (4/6)	1
M2-7067	M2-7067S	L right 100°	7.5 mm	10 (4/6)	1
M2-7068	M2-7068S	L left 100°	7.5 mm	6 (3/3)	1
M2-7069	M2-7069S	L right 100°	7.5 mm	6 (3/3)	1
M2-7070	M2-7070S	L left 100°	7.5 mm	4 (2/2)	1
M2-7071	M2-7071S	L right 100°	7.5 mm	4 (2/2)	1

T Plates

Material: Titanium (ASTM F67)
Plate thickness: 1.0 mm

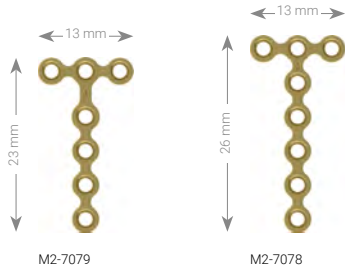

Art. No.	STERILE	Description	Bar	Holes	Pieces / Pkg
M2-7078	M2-7078S	T		8 (3/5)	1
M2-7079	M2-7079S	T	6 mm	7 (3/4)	1

Y Plates

Material: Titanium (ASTM F67)
Plate thickness: 1.0 mm

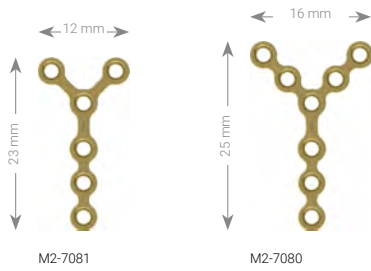

Art. No.	STERILE	Description	Bar	Holes	Pieces / Pkg
M2-7080	M2-7080S	Y	6 mm	8 (5/3)	1
M2-7081	M2-7081S	Y	6 mm	6 (3/3)	1

Z Plates

Material: Titanium (ASTM F67)
Plate thickness: 1.0 mm

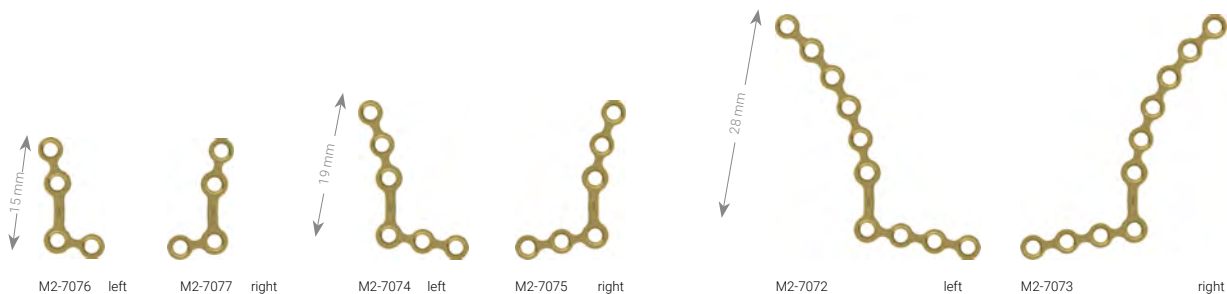

Art. No.	STERILE	Description	Bar	Holes	Pieces / Pkg
M2-7072	M2-7072S	Z left 100°	7.5 mm	10 (4/6)	1
M2-7073	M2-7073S	Z right 100°	7.5 mm	10 (4/6)	1
M2-7074	M2-7074S	Z left 100°	7.5 mm	6 (3/3)	1
M2-7075	M2-7075S	Z right 100°	7.5 mm	6 (3/3)	1
M2-7076	M2-7076S	Z left 100°	7.5 mm	4 (2/2)	1
M2-7077	M2-7077S	Z right 100°	7.5 mm	4 (2/2)	1

X Plates

Material: Titanium (ASTM F67)
Plate thickness: 1.0 mm

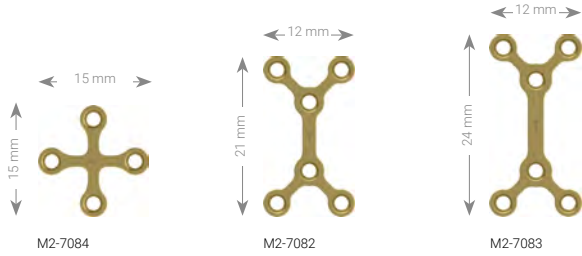

Art. No.	STERILE	Description	Bar	Holes	Pieces / Pkg
M2-7082	M2-7082S	X	9 mm	6	1
M2-7083	M2-7083S	X	12 mm	6	1
M2-7084	M2-7084S	X		4	1

H Plate

Material: Titanium (ASTM F67)
Plate thickness: 1.0 mm

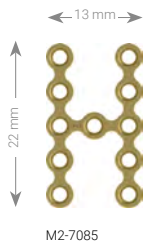

Art. No.	STERILE	Description	Bar	Holes	Pieces / Pkg
M2-7085	M2-7085S	H	4.5 mm	11	1

Orbital Rim Plates

Material: Titanium (ASTM F67)
Plate thickness: 1.0 mm



Art. No.	STERILE	Description	Holes	Pieces / Pkg
M2-7086	M2-7086S	curved		121
M2-7087	M2-7087S	curved		61

1.2 Cortical Screws, HexaDrive 4

Material: Titanium alloy (ASTM F136)



∅ 1.2 mm

Length	Art. No.	STERILE	Pieces / Pkg
3 mm	M2-5214.03/1	M2-5214.03/1S	1
4 mm	M2-5214.04/1	M2-5214.04/1S	1
5 mm	M2-5214.05/1	M2-5214.05/1S	1
6 mm	M2-5214.06/1	M2-5214.06/1S	1
7 mm	M2-5214.07/1	M2-5214.07/1S	1
8 mm	M2-5214.08/1	M2-5214.08/1S	1
9 mm	M2-5214.09/1	M2-5214.09/1S	1
11 mm	M2-5214.11/1	M2-5214.11/1S	1

Art. No.	Pieces / Pkg
M2-5214.03	5
M2-5214.04	5
M2-5214.05	5
M2-5214.06	5
M2-5214.07	5
M2-5214.08	5
M2-5214.09	5
M2-5214.11	5

1.5 Cortical Screws, HexaDrive 4

Material: Titanium alloy (ASTM F136)



∅ 1.5 mm

Length	Art. No.	STERILE	Pieces / Pkg
3 mm	M2-5224.03/1	M2-5224.03/1S	1
4 mm	M2-5224.04/1	M2-5224.04/1S	1
5 mm	M2-5224.05/1	M2-5224.05/1S	1
6 mm	M2-5224.06/1	M2-5224.06/1S	1
7 mm	M2-5224.07/1	M2-5224.07/1S	1
8 mm	M2-5224.08/1	M2-5224.08/1S	1
9 mm	M2-5224.09/1	M2-5224.09/1S	1
11 mm	M2-5224.11/1	M2-5224.11/1S	1

Art. No.	Pieces / Pkg
M2-5224.03	5
M2-5224.04	5
M2-5224.05	5
M2-5224.06	5
M2-5224.07	5
M2-5224.08	5
M2-5224.09	5
M2-5224.11	5

1.5 SpeedTip Screws, HexaDrive 4

Material: Titanium alloy (ASTM F136)



∅ 1.5 mm

Length	Art. No.	STERILE	Pieces / Pkg
4 mm	M2-5223.04/1	M2-5223.04/1S	1
5 mm	M2-5223.05/1	M2-5223.05/1S	1
6 mm	M2-5223.06/1	M2-5223.06/1S	1
7 mm	M2-5223.07/1	M2-5223.07/1S	1
8 mm	M2-5223.08/1	M2-5223.08/1S	1
9 mm	M2-5223.09/1	M2-5223.09/1S	1

Art. No.	Pieces / Pkg
M2-5223.04	5
M2-5223.05	5
M2-5223.06	5
M2-5223.07	5
M2-5223.08	5
M2-5223.09	5

1.8 Cortical Screws, HexaDrive 4

Material: Titanium alloy (ASTM F136)



∅ 1.8 mm

Length	Art. No.	STERILE	Pieces / Pkg
3 mm	M2-5234.03/1	M2-5234.03/1S	1
4 mm	M2-5234.04/1	M2-5234.04/1S	1
5 mm	M2-5234.05/1	M2-5234.05/1S	1
6 mm	M2-5234.06/1	M2-5234.06/1S	1
7 mm	M2-5234.07/1	M2-5234.07/1S	1
8 mm	M2-5234.08/1	M2-5234.08/1S	1
9 mm	M2-5234.09/1	M2-5234.09/1S	1
11 mm	M2-5234.11/1	M2-5234.11/1S	1

Art. No.	Pieces / Pkg
M2-5234.03	5
M2-5234.04	5
M2-5234.05	5
M2-5234.06	5
M2-5234.07	5
M2-5234.08	5
M2-5234.09	5
M2-5234.11	5

Twist Drills Ø 1.0 mm (Core Hole 1.2 Screws)



Art. No.	STERILE	Description	Stop	Length	Shaft End	Pieces / Pkg
M2-3012	M2-3012S		5 mm	35 mm	Dental	1
M2-3022	M2-3022S		5 mm	48 mm	Stryker J-Latch	1
M2-3032	M2-3032S		7 mm	37 mm	Dental	1
M2-3042	M2-3042S		7 mm	50 mm	Stryker J-Latch	1
M2-3052	M2-3052S		25 mm	55 mm	Dental	1
M2-3062	M2-3062S		25 mm	68 mm	Stryker J-Latch	1
M2-3382	M2-3382S	for drill guide M2-2202	25 mm	99 mm	Dental	1
M2-3392	M2-3392S	for drill guide M2-2202	25 mm	112 mm	Stryker J-Latch	1

Twist Drills Ø 1.2 mm (Gliding Hole 1.2 Screws)



Art. No.	STERILE	Description	Stop	Length	Shaft End	Pieces / Pkg
M2-3072	M2-3072S		25 mm	55 mm	Dental	1
M2-3082	M2-3082S		25 mm	68 mm	Stryker J-Latch	1
M2-3322	M2-3322S	for drill guide M2-2202	25 mm	99 mm	Dental	1
M2-3332	M2-3332S	for drill guide M2-2202	25 mm	112 mm	Stryker J-Latch	1

Twist Drills Ø 1.2 mm (Core Hole 1.5 Screws)



M2-3122



M2-3132



M2-3142



M2-3152



M2-3162



M2-3172



M2-3402



M2-3412

Art. No.	STERILE	Description	Stop	Length	Shaft End	Pieces / Pkg
M2-3122	M2-3122S		5 mm	35 mm	Dental	1
M2-3132	M2-3132S		5 mm	48 mm	Stryker J-Latch	1
M2-3142	M2-3142S		7 mm	37 mm	Dental	1
M2-3152	M2-3152S		7 mm	50 mm	Stryker J-Latch	1
M2-3162	M2-3162S		25 mm	55 mm	Dental	1
M2-3172	M2-3172S		25 mm	68 mm	Stryker J-Latch	1
M2-3402	M2-3402S	for drill guide M2-2202	25 mm	99 mm	Dental	1
M2-3412	M2-3412S	for drill guide M2-2202	25 mm	112 mm	Stryker J-Latch	1

Twist Drills Ø 1.5 mm (Gliding Hole 1.5 Screws)



M2-3182



M2-3342



M2-3192



M2-3352

Art. No.	STERILE	Description	Stop	Length	Shaft End	Pieces / Pkg
M2-3182	M2-3182S		25 mm	55 mm	Dental	1
M2-3192	M2-3192S		25 mm	68 mm	Stryker J-Latch	1
M2-3342	M2-3342S	for drill guide M2-2202	25 mm	99 mm	Dental	1
M2-3352	M2-3352S	for drill guide M2-2202	25 mm	112 mm	Stryker J-Latch	1

Twist Drills Ø 1.5 mm (Core Hole 1.8 Screws)



M2-3212



M2-3222



M2-3232



M2-3242



M2-3252



M2-3262



M2-3422



M2-3452

Art. No.	STERILE	Description	Stop	Length	Shaft End	Pieces / Pkg
M2-3212	M2-3212S		5 mm	35 mm	Dental	1
M2-3222	M2-3222S		5 mm	48 mm	Stryker J-Latch	1
M2-3232	M2-3232S		7 mm	37 mm	Dental	1
M2-3242	M2-3242S		7 mm	50 mm	Stryker J-Latch	1
M2-3252	M2-3252S		25 mm	55 mm	Dental	1
M2-3262	M2-3262S		25 mm	68 mm	Stryker J-Latch	1
M2-3422	M2-3422S	for drill guide M2-2202	25 mm	99 mm	Dental	1
M2-3452	M2-3452S	for drill guide M2-2202	25 mm	112 mm	Stryker J-Latch	1

Twist Drills Ø 1.8 mm (Gliding Hole 1.8 Screws)



M2-3272



M2-3362



M2-3282



M2-3372

Art. No.	STERILE	Description	Stop	Length	Shaft End	Pieces / Pkg
M2-3272	M2-3272S		25 mm	55 mm	Dental	1
M2-3282	M2-3282S		25 mm	68 mm	Stryker J-Latch	1
M2-3362	M2-3362S	for drill guide M2-2202	25 mm	99 mm	Dental	1
M2-3372	M2-3372S	for drill guide M2-2202	25 mm	112 mm	Stryker J-Latch	1

Drill Guide



Art. No.	Size	Length	Pieces / Pkg
M2-2202	1.2-1.8	164 mm	1

Depth Gauge



M2-2250

Art. No.	Size	Description	Length	Pieces / Pkg
M2-2250	1.2-2.3		153 mm	1

Screwdriver Handles



M2-2001



M2-2003

Art. No.	Description	Length	Pieces / Pkg
M2-2001	type 2 (hand-driven small, AO coupling)	121 mm	1
M2-2003	type 1 (finger-driven, AO coupling)	121 mm	1

Screwdriver Blade



1:1

Art. No.	Interface	Description	Length	Pieces / Pkg
M2-2004	HD4	self-holding	80 mm	1

Plate and Screw Holding Forceps



M-2009



M-2019

Art. No.	Description	Length	Pieces / Pkg
M-2009	angled, small	150 mm	1
M-2019	angled, large	200 mm	1

Plate Cutting Pliers

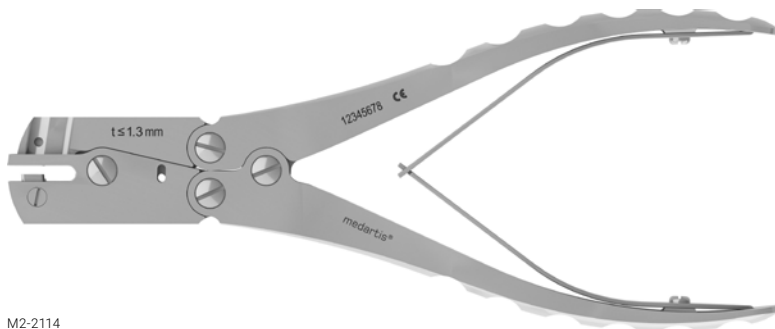

M2-2114



A-2046

Art. No.	Size	Description	Length	Pieces / Pkg
M2-2114		t ≤ 1.3 mm	204 mm	1
A-2046	1.2–2.8		207 mm	1

Mesh Cutting Pliers



M2-2870

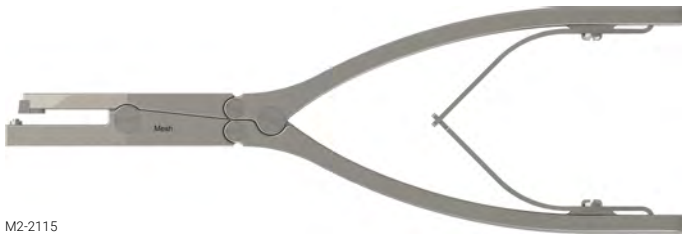

M2-2115

Art. No.	Description	Length	Pieces / Pkg
M2-2870	curved left	127 mm	1
M2-2115		180 mm	1

Plate Bending Pliers



M2-2000



M2-2002



M2-2012

Art. No.	Size	Description	Length	Pieces / Pkg
M2-2000		flat	152 mm	1
M2-2002	1.2-1.8		152 mm	1
M2-2012	1.2-1.8	with pin	140 mm	1

Orbital Retractors



M2-2121



M2-2122



M2-2123

Art. No.	Description	Length	Pieces / Pkg
M2-2121	right	200 mm	1
M2-2122	left	200 mm	1
M2-2123		200 mm	1

Elevator and Mesh Forming Instrument



Art. No.	Length	Pieces / Pkg
M2-2872	190 mm	1

Midface Model

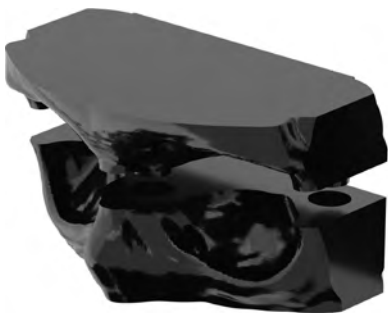

Art. No.	Description	Length	Pieces / Pkg
M2-2874	two pieces	101 mm	1

Containers

Plates



M2-6005.008
(excl. implants)



M2-6005.009
(excl. implants)



M2-6005.010
(excl. implants)

Art. No.	Description	Dimensions (W x L)	Pieces / Pkg
M2-6005.008	Implant Case, MIDFACE, Plates, t0.5	120 x 240 mm	1
M2-6005.009	Implant Case, MIDFACE, Plates, t0.6 / 0.7	120 x 240 mm	1
M2-6005.010	Implant Case, MIDFACE, Plates, t1.0	120 x 240 mm	1
M-6726	Lid f. Implant and Instr.Case 120 x 240mm	120 x 240 mm	1

Screws

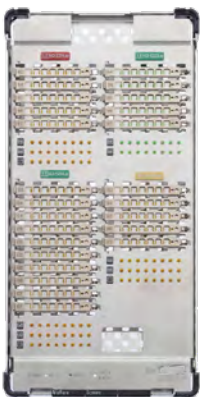

M2-6005.013 with M2-6005.014
(excl. implants)

Art. No.	Description	Dimensions (W x L)	Pieces / Pkg
M2-6005.013	Implant Case, MIDFACE, Screws 1.2 / 1.5 / 1.8	120 x 240 mm	1
M2-6005.014	Screw Tray, MIDFACE, Screws 1.2 / 1.5 / 1.8	120 x 240 mm	1
M-6726	Lid f. Implant and Instr.Case 120 x 240mm	120 x 240 mm	1

Instruments



M2-6005.001 with
M2-6005.004* / M2-6005.005*,
M2-6005.006 and M2-6005.007
(excl. instruments)



M2-6005.004*
(excl. instruments)



M2-6005.006
(excl. instruments)



M2-6005.007
(excl. instruments)

Art. No.	Description	Dimensions (W x L)	Pieces / Pkg
M2-6005.001	Instrument Case, MIDFACE	240 x 240 mm	1
M2-6005.004*	Instrument Tray, MIDFACE, 3, Stryker	240 x 240 mm	1
M2-6005.005*	Instrument Tray, MIDFACE, 3, Dental	240 x 240 mm	1
M2-6005.006	Instrument Tray, MIDFACE, 2	240 x 240 mm	1
M2-6005.007	Instrument Tray, MIDFACE, 1	240 x 240 mm	1
M-6727	Lid f. Implant and Instr.Case 240 x 240mm	240 x 240 mm	1

OPS



M2-6005.043 with
M2-6005.042* / M2-6005.046* and
M2-6005.044 (excl. implants and
instruments)



M2-6005.044 (excl. instruments)

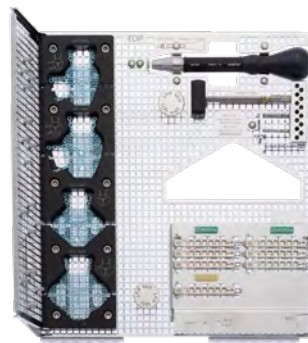

M2-6005.042* (excl. implants
and instruments)

Art. No.	Description	Dimensions (W x L)	Pieces / Pkg
M2-6005.043	Instrument Case, OPS	240 x 240 mm	1
M2-6005.044	Instrument Tray, OPS, 1	240 x 240 mm	1
M2-6005.042*	Instrument Tray, OPS, 2, Stryker	240 x 240 mm	1
M2-6005.046*	Instrument Tray, OPS, 2, Dental	240 x 240 mm	1
M-6727	Lid f. Implant and Instr.Case 240 x 240mm	240 x 240 mm	1

Additional configurations available on request.

* Choose between Stryker or Dental Instrument Tray based on drill coupling

R_MIDFACE2-01010001_v0 / ©2021-08, Medartis AG, Switzerland. All technical data subject to alteration.

MANUFACTURER & HEADQUARTERS

Medartis AG | Hochbergerstrasse 60E | 4057 Basel / Switzerland
P +41 61 633 34 34 | F +41 61 633 34 00 | www.medartis.com

SUBSIDIARIES

Australia | Austria | Brazil | China | France | Germany | Japan | Mexico | New Zealand | Poland | Spain | UK | USA

For detailed information regarding our subsidiaries and distributors, please visit www.medartis.com

CE
0197

CE

Disclaimer: This information is intended to demonstrate the Medartis portfolio of medical devices. A surgeon must always rely on her or his own professional clinical judgement when deciding whether to use a particular product when treating a particular patient. Medartis is not giving any medical advice. The devices may not be available in all countries due to registration and / or medical practices. For further questions, please contact your Medartis representative (www.medartis.com). This information contains CE-marked products.
For US only: Federal law restricts this device to sale by or on the order of a physician.